

***autolamps***

A Clarience Technologies Company



**PATCH HARNESS SYSTEMS**  
**A CABLE SOLUTION FOR ALL YOUR NEEDS**

Version 5.8 - 2024

## Functional, Long Lasting OEM Quality



### Easy Lighting Upgrade for Trays

Upgrading or fitting LED rear lighting to trays has never been made easier with our new plugin lamp and patch cable system. We have made available our most popular rear combination lamps that have been prewired with load resistors assisting with fast flashing indicators or error messages and terminated with quality Deutsch connectors. The key is to adapt to the vehicles' existing harness system with the additional capability to adapt to our existing plugin marker and licence plate lamps. Benefits include no soldering, leading to an increase in productivity, saving time and money. Our comprehensive range of vehicle patch cable adapter plugs suiting most popular branded vehicles will not disappoint.



### Bullbar LED Upgrade

The patch harness system makes upgrading or fitting LEDs to vehicle bullbars easy by offering our most popular front position/indicator lamps and having them prewired with the suitable harness and O.E.M. vehicle connectors. The key is the ability to adapt to the vehicles' existing harness system. D.I.Y. installers can also benefit, allowing fabricators to send completed bars out to their customers. With our comprehensive range of vehicle patch cable adapters suiting the most popular branded vehicles, a solution to almost any application is available.



- **Add any Light Anywhere in the Harness System**
- **Easily replace damaged lighting with minimal downtime**
- **Heavy Duty Water-resistant Cable, Plugs and Connectors**
- **System Adaptability and Customisation**
- **All Lights Compliant with ECE or ADR**
- **RoHS Compliant Cables, Plugs and Lights**

**Rear Patch System**  
Page 4-5



**Lamps and Accessories**  
Page 6-11



**Front Indicators**  
Page 12-13



**Driving Lamps**  
Page 14-15





## System Functionality and Adaptability

Explicitly designed to be easily and quickly installed without the need to cut, splice, solder, join or tape wire joins. This patch harness system will reduce fitting times which in turn saves fitters time and money. This patch system is ever-expanding with new brands and adaptability to suit. We can also help with bespoke, custom OE or specific requirements making the process entirely adaptable for your particular needs.



### Side Indicator Upgrade

We have made available our most popular category six side direction indicator prewired with a suitable harness and O.E.M. vehicle connectors. A GVM upgrade or a new installation, fitting a category 5/6 approved side direction indicator to a vehicle, has never been made easier with our new plugin lamp and patch cable system. The key is the ability to adapt to the vehicles' existing harness system. With our comprehensive range of vehicle patch cable adapter plugs suiting most popular branded vehicles, you will not be disappointed with the choice.



### Driving Light Compatibility

Driving Lighting upgrades has never been made easier with our new plugin lamp and patch cable system. The connection requires virtually no wiring using the vehicle-specific patch cable to tap into and isolate the high beam signal. We offer an extensive range of vehicle patch cable adapters serving the most popular branded vehicles, and you will be satisfied with the options available.



### Rigid Body Harnessing System

Our research and development team continually adapt to keep up with as many vehicles as possible. The Rigid body trucks can also benefit from this system, with numerous possibilities to advance your Lighting and wiring options.

**Side Direction**  
Page 16-17

**Brand Adaptability**  
Page 18-37

**Rigid Body Kits**  
Page 38-61

**Plugs & Connectors**  
Page 62-65







## Designed for Tray Type Vehicles

Upgrading or fitting trays to LED rear lighting has never been made easier with our new plugin lamp and patch cable system. We have made available our most popular rear combination lamps that have been prewired with load resistors assisting with fast flashing indicators or error messages and terminated with quality Deutsch connectors.

- 1 Vehicle Factory Loom
- 2 Vehicle Patch Lead
- 3 Rear Combination Lamp

### Compatible with the following brands

- Suits Holden Colorado
- Suits Nissan Navara
- Suits Toyota Landcruiser
- Suits Dodge Ram 1500
- Suits Hino Trucks

- Suits Mazda BT-50
- Suits Ford Ranger
- Suits Volkswagen Amarok
- Suits Isuzu Trucks
- Suits Toyota Hilux

- Suits Mitsubishi Triton
- Suits Isuzu D-MAX
- Suits LDV T60/T70
- Suits Fuso Trucks
- Suits LDV

- Suits Dodge
- Suits Great Wall
- Suits Holden
- Suits Many More



## Flexibility for any Application or Wiring Requirements

The key is the ability to adapt to the vehicles' existing harness system. With our comprehensive range of vehicle patch cable adapter plugs suiting most popular branded vehicles, you will not be disappointed with the choice. A handy additional feature is the ability to adapt to our existing plugin marker and licence plate lamps. To complete the system, we also have an extensive range of separate patch plugs and connectors. We can also help with bespoke, custom OE or specific requirements as well.



### Prewired Lamp and patch lead to vehicle loom

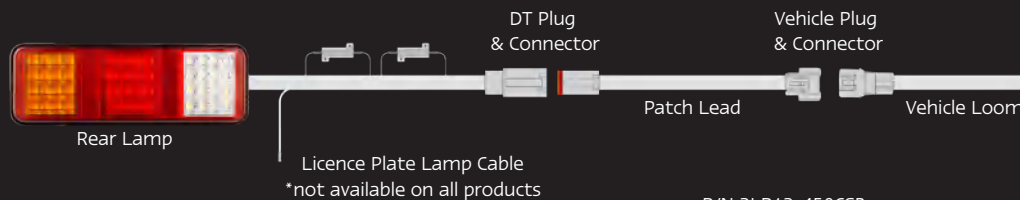

### Prewired CSB Lamp and patch lead to vehicle loom

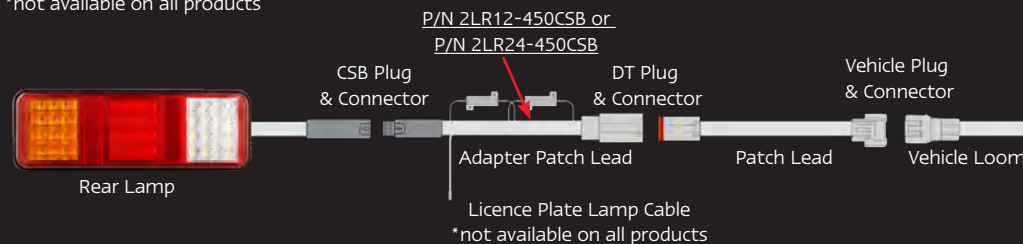

### Prewired Lamp and hard wire to vehicle loom

FOR VEHICLES WHERE A PATCH IS NOT AVAILABLE.

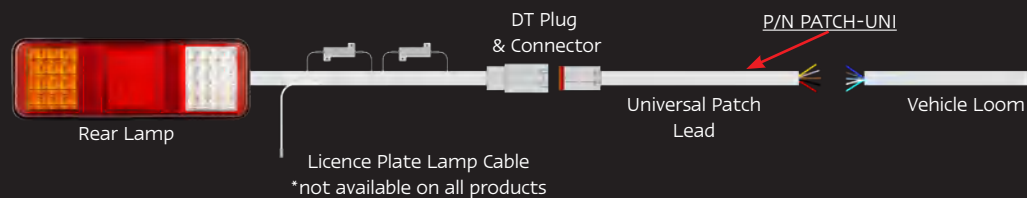

### LED Lamp with bare ends and patch lead to vehicle loom

FOR ADAPTING LIGHTS THAT ARE NOT AVAILABLE WITH PRE-TERMINATED PLUGS

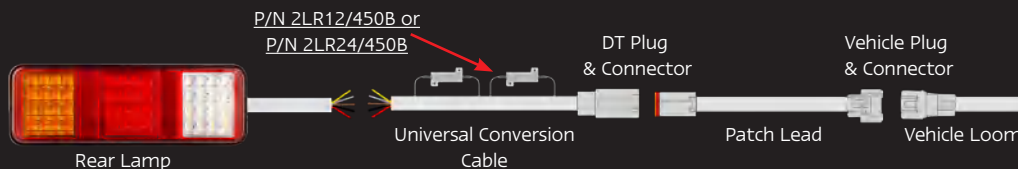

**Warning:** The resistors/modules can reach temperatures up to 170°C, do not mount the resistor on any surface that can be melted by the heat of the resistor, this includes plastics, hoses or painted surfaces.

# Rear Combination Lamps

**Note:** When using load resistors in a vehicle that has lamp failure monitoring, failure of the lamp will not be detected.



## 282 Series - SIZE 284MM X 100MM X 27MM

Part No	Voltage	Function	Cable
S0282ARWM2LR450	12 VOLT	STOP/TAIL/INDICATOR/REVERSE	450MM WITH 2 X 12V RESISTORS, TERMINATED WITH DEUTSCH CONNECTOR AND 500MM LICENCE PLATE CABLE WITH 2 PIN MALE PLUG



## 280 Series - SIZE 282MM X 95MM X 28MM

Part No	Voltage	Function	Cable
280ARWM2LR12/450	12 VOLT	STOP/TAIL/INDICATOR/REVERSE COLOURED LENS	450MM WITH 2 X 12V RESISTORS, TERMINATED WITH DEUTSCH CONNECTOR
280ARWM2LR24/450	24 VOLT	STOP/TAIL/INDICATOR/REVERSE COLOURED LENS	450MM WITH 2 X 24V RESISTORS, TERMINATED WITH DEUTSCH CONNECTOR
280TARWM2LR12-450	12 VOLT	STOP/TAIL/INDICATOR/REVERSE TINTED LENS COLOURED LEDs	450MM WITH 2 X 12V RESISTORS, TERMINATED WITH DEUTSCH CONNECTOR



## 250 Series - SIZE 250MM X 80MM X 24MM

Part No	Voltage	Function	Cable
S0250ARWM2LR450	12 VOLT	STOP/TAIL/INDICATOR/REVERSE/REFLECTOR	450MM WITH 2 X 12V RESISTORS, TERMINATED WITH DEUTSCH CONNECTOR AND 500MM LICENCE PLATE CABLE WITH 2 PIN MALE PLUG



## 82 Series - SIZE 281MM X 101MM X 30MM (CLEAR LENS COLOURED LEDs)

Part No	Voltage	Function	Cable
S082BARWCC2LR12	12 VOLT	STOP/TAIL/INDICATOR REVERSE WITH LICENCE PLUG	450MM WITH 2 X 12V RESISTORS, TERMINATED WITH DEUTSCH CONNECTOR & 500MM LICENCE CABLE WITH 2 PIN MALE PLUG
S082BARWCC2LR12-1	12 VOLT	STOP/TAIL/INDICATOR REVERSE	450MM WITH 2 X 12V RESISTORS, TERMINATED WITH DEUTSCH CONNECTOR (DOES NOT HAVE LICENCE CABLE WITH PLUG)



## 275 Series - SIZE 275MM X 100MM X 33MM

Part No	Voltage	Function	Cable
S0275GARWM2LR450 275GARWM2LR21W450	12 VOLT	STOP/TAIL/INDICATOR/REVERSE/REFLECTOR	450MM WITH 2 X 12V RESISTORS, TERMINATED WITH DEUTSCH CONNECTOR AND 500MM LICENCE PLATE CABLE WITH 2 PIN MALE PLUG.(275GARWM2LR21W450 - 21 WATT LOAD RESISITOR)

# Rear Combination Lamps

**Note:** When using load resistors in a vehicle that has lamp failure monitoring, failure of the lamp will not be detected.



## 283 Series - SIZE 283MM x 100MM x 25MM

Part No	Voltage	Function	Cable
S0283ARWM2LR12	12 VOLT	STOP/TAIL/IND/REV/REFLECTOR	450MM WITH 2 x RESISTORS, TERMINATED WITH DEUTSCH CONNECTOR AND 500MM LICENCE PLATE CABLE WITH 2 PIN MALE PLUG
S0283ARWM2LR24	24 VOLT	STOP/TAIL/IND/REV/REFLECTOR	450MM WITH 2 x RESISTORS, TERMINATED WITH DEUTSCH CONNECTOR AND 500MM LICENCE PLATE CABLE WITH 2 PIN MALE PLUG



## 284 Series - SIZE 284MM x 100MM x 37MM

Part No	Voltage	Function	Cable
S0284LHS	12 VOLT	STOP/DIFFUSED TAIL/SEQUENTIAL IND/REV/REFLECTOR, LEFT SIDE	450MM WITH 2 x 12V RESISTORS, TERMINATED WITH DEUTSCH CONNECTOR AND 500MM LICENCE PLATE CABLE WITH 2 PIN MALE PLUG.
S0284RHS	12 VOLT	STOP/DIFFUSED TAIL/SEQUENTIAL IND/REV/REFLECTOR, RIGHT SIDE	450MM WITH 2 x 12V RESISTORS, TERMINATED WITH DEUTSCH CONNECTOR AND 500MM LICENCE PLATE CABLE WITH 2 PIN MALE PLUG.



## Maxilamp Series - SIZE 370MM x 135MM x 40MM

Part No	Voltage	Function	Cable
S0MAXI2LR/450B	12 VOLT	STOP/TAIL/INDICATOR/REVERSE/REFLECTOR	450MM WITH 2 x 12V RESISTORS, TERMINATED WITH DEUTSCH CONNECTOR AND 500MM LICENCE PLATE CABLE WITH 2 PIN MALE PLUG.



One side pictured

## Maxilamp Rear Combo Kit - REAR LAMP SIZE 125MM ROUND x 40MM

Part No	Voltage	Function	Cable
PNPK-MAXI1XR INCLUDES BOTH SIDES	12 VOLT	STOP/TAIL/INDICATOR/REVERSE/LICENCE LAMP AND CABLE KIT	PLUG & PLAY KIT - MAXILAMP C1RXRE x4, MAXILAMP C1XRE x2, 41BLMDT x2, 4x LR12, DT CONNECTORS.



# Rear Combination Lamps

**Note:** When using load resistors in a vehicle that has lamp failure monitoring, failure of the lamp will not be detected.



**355 Series** - SIZE 356MM X 86MM X 35MM

Part No	Notes	Function
355ARWMLCSB	LEFT HAND SIDE	CHROME LENS, STOP/DIFFUSED TAIL/SEQUENTIAL INDICATOR/REVERSE/REFLECTOR
355ARWMRCSB	RIGHT HAND SIDE	



**355 Series** - SIZE 356MM X 86MM X 35MM

Part No	Notes	Function
355BARWMLCSB	LEFT HAND SIDE	BLACK LENS, STOP/DIFFUSED TAIL/SEQUENTIAL INDICATOR/REVERSE/REFLECTOR
355BARWMRCSB	RIGHT HAND SIDE	



**385 Series** - SIZE 387MM X 105MM X 30.5MM

Part No	Notes	Function
385ARWMLCSB	LEFT HAND SIDE	STOP/DIFFUSED TAIL/SEQUENTIAL INDICATOR/REVERSE
385ARWMRCSB	RIGHT HAND SIDE	



**3851 Series** - SIZE 387MM X 105MM X 30.5MM

Part No	Notes	Function
3851ARWMLCSB	LEFT HAND SIDE	STOP/TAIL/INDICATOR/REVERSE/REFLECTOR
3851ARWMRCSB	RIGHT HAND SIDE	



**3852 Series** - SIZE 387MM X 105MM X 30.5MM

Part No	Notes	Function
3852ARWMLCSB	LEFT HAND SIDE	STOP/DIFFUSED TAIL/INDICATOR/REVERSE
3852ARWMRCSB	RIGHT HAND SIDE	



**3853 Series** - SIZE 387MM X 105MM X 30.5MM

Part No	Notes	Function
3853ARWMLCSB	LEFT HAND SIDE	STOP/DIFFUSED TAIL/SEQUENTIAL INDICATOR/REVERSE
3853ARWMRCSB	RIGHT HAND SIDE	

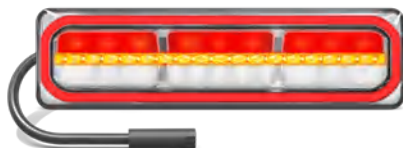

**3854 Series** - SIZE 387MM X 105MM X 30.5MM

Part No	Notes	Function
3854ARWMLCSB	LEFT HAND SIDE	STOP/DIFFUSED TAIL/SEQUENTIAL INDICATOR/REVERSE
3854ARWMRCSB	RIGHT HAND SIDE	



**3855 Series** - SIZE 387MM X 105MM X 30.5MM

Part No	Notes	Function
3855ARWMLCSB	LEFT HAND SIDE	STOP/DIFFUSED TAIL/INDICATOR/REVERSE
3855ARWMRCSB	RIGHT HAND SIDE	



# Rear Lamps, Licence Plate, Reverse Lamps and Accessories

**Note:** When using load resistors in a vehicle that has lamp failure monitoring, failure of the lamp will not be detected.



**3856 Series** - SIZE 387MM X 105MM X 30.5MM

Part No	Notes	Function
386ARWMLCSB	LHS	STOP/DIFFUSED TAIL/INDICATOR/REVERSE
386ARWMRCB	RHS	



## CSB Adapter Patch Lead

Part No	Notes	Function
2LR12-450CSB	12 VOLT	ADAPTS OUR 7 CORE CSB LAMPS TO WORK WITH OUR TAIL LAMP PATCH SYSTEM. VOLTAGE SPECIFIC.
2LR24-450CSB	24 VOLT	(2LR21W-450CSB - 21 WATT LOAD RESISTOR)
2LR21W-450CSB	12 VOLT	

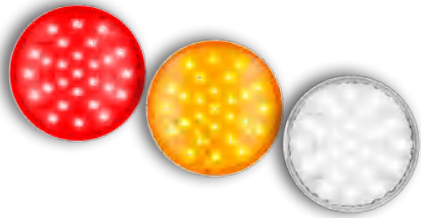

## 110 Series Single Function

Part No	Function
110RMB	STOP/TAIL
110AMB	INDICATOR
110WMB	REVERSE



## 130 Series Single Function

Part No	Function
130RMB	STOP/TAIL/REFLECTOR
130AMB	INDICATOR
130WMB	REVERSE



## Single Function Grommets

Part No	Function
53401	ROUND RUBBER GROMMET
59401	RECTANGLE RUBBER GROMMET

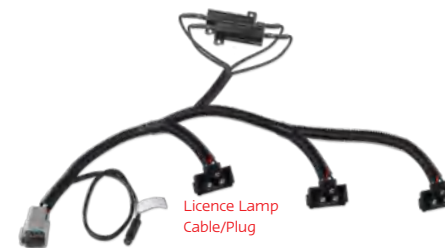

## Single Function Adapter

Part No	Function
3PSTIR-2LR12-450B	53102x3, DT04-6P, 2x 12V RESISTORS, 450MM LENGTH.



**11 Series** - SIZE 89MM X 30MM X 8MM

Part No	Function
11WM-2AMP	REVERSE LAMP WITH 25CM CABLE AND 2AMP PLUG, 12-24V



**Bracket** - SIZE 228MM X 215MM

Part No	Function
LC300REVBKT	REVERSE LAMP ALLOY SINGLE TAILGATE MOUNTING BRACKET



## Reverse Adapter Patch Lead

Part No	Function
LC300TGL00M	REVERSE LAMP TAILGATE HARNESS

**Note:** Currently only available for the Landcruiser300 Series See page 28 for more information

# Rear Lamps, Licence Plate, Reverse Lamps and Accessories

**Note:** When using load resistors in a vehicle that has lamp failure monitoring, failure of the lamp will not be detected.



### Work/Reverse Lamp

Part No	Function
7312BMCSB	FLOOD LAMP WITH 2 CORE FEMALE PLUG 12-24V

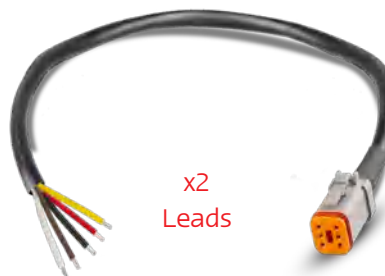

x2 Leads

### Universal Patch Cable

Part No	Function
PATCH-UNI	PAIR OF UNIVERSAL PATCH LEAD DT06 AND BARE WIRES FOR HARD WIRE



### Reverse Beeper/Squawker

Part No	Function
2PF200RAB	REVERSE BEEPER 12-24V 200MM CABLE 102DB FIXED
2PF200ETB	REVERSE BEEPER 12-24V 200MM CABLE 102DB FIXED
2PF200SQB	REVERSE SQUAWKER 12-24V 200MM CABLE 102DB FIXED



x2 Leads

### Patch Relay

Part No	Function
PATCH-RELAY	PAIR OF 4-PIN RELAY WITH 450MM CABLE AND DT04-4P PLUG



### Reverse Breakout Patch

Part No	Function
BOPATCH-REVCSB	DEUTSCH EXTENSION WITH 2 CORE CABLE WITH 500MM CABLE WITH MALE PLUG FOR REVERSE



Licence Lamp Cable/Plug

### Universal Lamp Patch Cable

Part No	Function
2LR12/450B	450MM LENGTH. 2 x 12V RESISTORS. BARE WIRES AND DT04-6P CONNECTOR.
2LR24/450B	450MM LENGTH. 2 x 24V RESISTORS. BARE WIRES AND DT04-6P CONNECTOR.

# Rear Lamps, Licence Plate, Reverse Lamps and Accessories

**Note:** When using load resistors in a vehicle that has lamp failure monitoring, failure of the lamp will not be detected.



### Licence Plate Resistor

Part No	Function
2PM.5LP	T10 TO 2 PIN MALE PLUG (PAIR) 12V ONLY



### Licence Plate Resistor

Part No	Function
2PM.5LPDT	DEUTSCH PLUGS (PAIR) 12V ONLY



### Licence Plate Lamp

Part No	Function
35BLMCSB	LICENCE PLATE LAMP 12-24V, 20CM CABLE AND FEMALE PLUG



### Licence Plate Lamp

Part No	Function
41BLMCSB	LICENCE PLATE LAMP 12-24V, 20CM CABLE AND FEMALE PLUG



### Licence Plate Lamp

Part No	Function
6434BW-MCSB	LICENCE PLATE LAMP 12-24V, 20CM CABLE AND FEMALE PLUG
6434CW-MCSB	CHROME LICENCE PLATE LAMP 12-24V, 20CM CABLE AND FEMALE PLUG

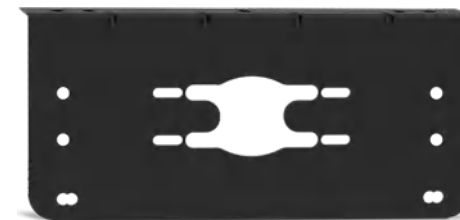

### Multi-Fit Bracket

Part No	Function
MFBKT	MULTI FIT STEEL BRACKET SUITS, 280, 282, 275, 80, 283, 284, TRIPLE COMBINATION LAMPS





## Bullbar Patch System for Front Position & Indicators

The patch harness system makes upgrading or fitting LEDs to vehicle bullbars easy by offering our most popular front position/indicator lamps and having them prewired with the suitable harness and O.E.M. vehicle connectors. The key is the ability to adapt to the vehicles existing harness system. D.I.Y. installers can also benefit, allowing fabricators to send completed bars out to their customers. With our comprehensive range of vehicle patch cable adapters suiting the most popular branded vehicles, a solution to almost any application is available.

- Upgrade From Globe Type
- Reduce Bar Fitment Time
- New O/E Installation
- Evolving Brand Compatibility



### Daytime Running Lamps and DRL Module

When used in conjunction with the below lamps, this module converts the lamp to operate as an ECE Approved Daytime Running Lamp. Requires one for each lamp. Voltage Range 9-30 Volt.



Part No	Function
BBPATCH-DRLHD3AMP	DRL WIRING CONVERTER, COMPATIBLE WITH BBPATCH SYSTEM, 3 AMP PLUGS.200MM CABLE EACH SIDE.
BBPATCH-DRLHD4AMP	DDRL WIRING CONVERTER, COMPATIBLE WITH BBPATCH SYSTEM, 4 AMP PLUGS.200MM CABLE EACH SIDE.

#### 175AWTB Series - SIZE 225MM X 56MM X 27MM

Part No	Voltage	Function	Cable
175AWTB-3AMP	12V	FRONT INDICATOR/ POSITION/DRL WITH BBPATCH-DRLHD3AMP	20CM WITH AMP PLUG



#### 80 Series - SIZE 80MM ROUND X 40MM

Part No	Voltage	Function	Cable
80AW-3AMP	12V	FRONT INDICATOR/ POSITION/DRL WITH BBPATCH-DRLHOTDOG	20CM WITH AMP PLUG



# Pre-wired Lamps with 3 Pin AMP Plug

## 135 Series - SIZE 135MM X 38MM X 24MM



Part No	Voltage	Function	Cable
135AW-3AMP	12V	FRONT INDICATOR/ POSITION, BRACKET	20CM WITH AMP PLUG
135AWG-3AMP	12V	FRONT INDICATOR/ POSITION, GROMMET	20CM WITH AMP PLUG



## 175 Series - SIZE 175MM X 50MM X 24MM

Part No	Voltage	Function	Cable
175AW-3AMP	12V	FRONT IND FRONT POSITION	20CM WITH AMP PLUG



## 11 Series - SIZE 89MM X 30MM X 8MM

Part No	Voltage	Function	Cable
11CAT1M-3AMP	12- 24V	FRONT INDICATOR	25CM WITH AMP PLUG
11FWMB-3AMP	12- 24V	FRONT POSITION	25CM WITH AMP PLUG



## 120034 Series - 98MM X 30MM X 8MM

Part No	Voltage	Function	Cable
120034CAT1-3AMP	12V- 24V	FRONT INDICATOR	20CM WITH AMP PLUG
120034AWM-3AMP	12V- 24V	FRONT IND FRONT POSITION	20CM WITH AMP PLUG



## 77 Series - SIZE 77MM X 52MM X 22MM

Part No	Voltage	Function	Cable
77ACM-3AMP	12- 24V	CAT 6 SIDE DIRECTION	20CM WITH AMP PLUG
77AM-3AMP	12- 24V	CAT 6 SIDE DIRECTION	20CM WITH AMP PLUG



## Hardwire Applications

Part No	Function	Cable
BBPATCH-UNI	HARDWIRE INTO VEHICLES THAT HAVE NO BBPATCH AVAILABLE FOR BULLBAR INDICATORS	85CM WITH AMP PLUG



## Driving Lamp/Light Bar Patch System - Modern Vehicles with LED Headlights

Driving Lighting upgrades has never been made easier with our new plugin lamp and patch cable system. The connection requires virtually no wiring using the vehicle-specific patch cable to tap into and isolate the high beam signal. We offer an extensive range of vehicle patch cable adapters serving most popular branded vehicles, and you will be very satisfied with the options available.

- **Upgrade From Globe Type**
- **New O/E Installation**
- **Save Time and Money**
- **Evolving Brand Compatibility**
- **Complete Harness Kit Available**







# Compatible Driving Lamps and Loom

Note: DLPATCH only gets the high beam signal. Park function requires separate wiring.



**7" TIR Series** - SIZE 189MM X 189MM X 65MM

Part No	Voltage	Function	Cable
TIR7	12/24	DRIVING LAMP/FRONT POSITION	200MM WITH PLUG

Twin Blister

**9" TIR Series** - SIZE 244MM X 241MM X 73MM

Part No	Voltage	Function	Cable
TIR9	12/24	DRIVING LAMP/FRONT POSITION	200MM WITH PLUG



Twin Blister



**9" DL245** - SIZE 245MM X 178MM X 109MM

Part No	Voltage	Function	Cable
DL245	12/24	DRIVING LAMP/FRONT POSITION	200MM WITH PLUG

Twin Blister

**9" DL226** - SIZE 226MM X 263MM X 114MM

Part No	Voltage	Function	Cable
DL226	12/24	DRIVING LAMP/FRONT POSITION	200MM WITH PLUG



Twin Blister

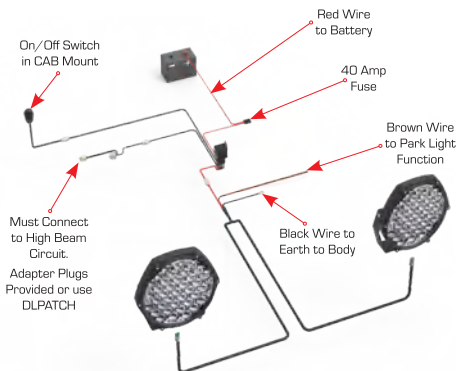

## Driving Light Harness Kit

SIZE 4M TOTAL LENGTH

Part No	Voltage	Function
TIRWH1	12/24	WIRING HARNESS KIT 4 METRES TOTAL LENGTH

- Includes H4 and HB3/4 Adapter
- Suitable for + or - Switched Vehicles



Part No	Function
DLPATCH-H4	DRIVE LIGHT PATCH H4 ADAPTER



Part No	Function
DLPATCH-HB34	DRIVE LIGHT PATCH HB3/HB4 ADAPTER



## Category 6 - Side Direction Indicator Patch System



We have made available our most popular category six side direction indicator prewired with a suitable harness and O.E.M. vehicle connectors. A GVM upgrade or a new installation, fitting a category 5/6 approved side direction indicator to a vehicle, has never been made easier with our new plugin lamp and patch cable system.

The key is the ability to adapt to the vehicles' existing harness system. With our comprehensive range of vehicle patch cable adapter plugs suiting most popular branded vehicles, you will not be disappointed with the choice.

### **Compatible with the following brands**

- Suits Toyota Landcruiser
- Suits Toyota HiAce
- Suits Ford Ranger
- Suits D-MAX
- Universal Adaptability



# Compatible Category 6 - Side Direction Indicator Lamps

**Note:** ADR13/00 (F2017C01072), 6.5.3. It is permitted to replace Category 5 Side Direction-indicator lamps with Category 6 Side Direction-indicator lamps in all instances.

Our Patch Harness System allows for an easy installation of our latest 77 series Category 6 side direction indicators. To ensure the perfect drill position, we have made available the 77M magnetic template alignment tool. To install, you find the Vehicles' front indicator plug, disconnect and then install the new patch cable. The patch cable includes a quality AMP super seal plug.

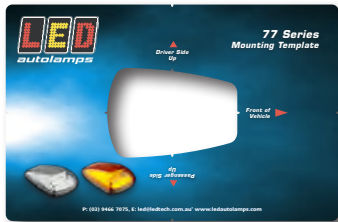

### 77M Fitting Guide Magnetic Template

USED TO ACCURATELY POSITION THE LAMP

THE 77 SERIES LAMPS ARE FITTED USING SUPPLIED 3M TAPE & SERRATED PLUG

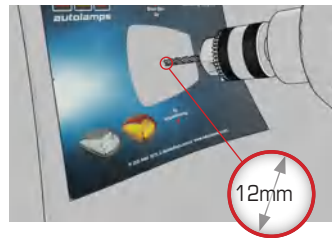

**P/N: 77M**

**P/N: 77M-DMAX** SEE PAGE 23

**P/N: 77M-RANGER** SEE PAGE 36

**P/N: 77M-RANGER22** SEE PAGE 36

#### Wiring Configuration

SUITS TOYOTA LANDCRUISER/HI-ACE, ISUZU D-MAX

PIN	COLOUR	FUNCTION
1	WHITE	EARTH
2	-	-
3	YELLOW	INDICATOR

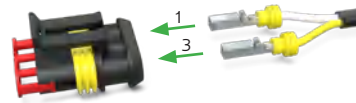

#### Wiring Configuration

SUITS TOYOTA HILUX

PIN	COLOUR	FUNCTION
1	YELLOW	INDICATOR
2	-	-
3	WHITE	EARTH

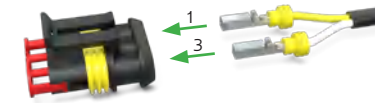



# Vehicle Brand Adaptability

Explicitly designed to be easily and quickly installed without the need to cut, splice, solder, join, or tape wire joins. The patch harness system will also reduce fitting times which in turn saves fitters time and money. This comprehensive patch system is ever-expanding with new brands and adaptability to suit. We can also help with bespoke, custom O/E or specific requirements making the process entirely adaptable for your particular needs.

## Section Colour Coding Key



### Rear Patch Cables

See Page 4



### Front Indicator

See Page 12



### Driving Lamps Light Bars

See Page 14



### Side Direction

See Page 16



### Power Patch

See Page 38

### Important Note:







Ensure you visually match the plug you require for your application with the plug pictures in this catalogue. This will avoid any mistakes in ordering.

## Brands by Page No.

• Dodge	18	• LDV	21	• Toyota	28-30	• Ssangyong	36	• Iveco	51
• Mazda	19	• Isuzu	22-23, 50	• Ford	32-35	• Mahindra	36	• Hyundai	52
• Holden	20	• Mitsubishi	24-25, 55	• Jeep	36	• Volkswagen	37		
• Great Wall	21	• Nissan	26-27, 52	• Suzuki	36	• Hino	48-49		

## DODGE RAM/LARAMIE/EXPRESS



Patch Application	Part No.	Picture	Notes	1500	2500	3500
 PLUGGED REAR PATCH CABLE	PATCH-RAM.UNI (INCLUDES X2 CABLES)		VISUALLY MATCH PLUGS ON AMERICAN CONVERSION VEHICLES			
 PLUGGED REAR PATCH CABLE	PATCH-RAM1500 (INCLUDES X2 CABLES)		VISUALLY MATCH PLUGS ON AMERICAN CONVERSION VEHICLES			











# MAZDA BT-50



**Important Note Regarding Tail Lamp Patch:**  
 Second Generation 2010 to 2020 Mazda BT50  
 (Produced by Ford) will use the PATCH-RANGER/BT50.

Third Generation 2020 Onwards Mazda BT50  
 (Produced by Isuzu) will use the PATCH-DMAX.

Ensure you visually match the plugs before ordering.

Patch Application	Part No.	Picture	Notes	<2020	2020+
 PLUGGED REAR PATCH CABLE	PATCH-RANGERBT50.UNI  (INCLUDES X2 CABLES)		BT-50 PRE MY20		
 PLUGGED REAR PATCH CABLE	PATCH-RANGERBT50  (INCLUDES X2 CABLES)		BT-50 PRE MY20		
 PLUGGED REAR PATCH CABLE	PATCH-DMAX  (INCLUDES X2 CABLES)		BT-50 MY20 ONWARDS		
 DRIVING LAMPS LIGHT BAR	DLPATCH-DMAXRG  (INCLUDES X1 CABLE)		MY20 ONWARDS		
 BULLBAR FRONT INDICATOR/ POSITION	BBPATCH-BT50.11  (INCLUDES X1 CABLE)		MY11-MY20 ONWARDS		
 BULLBAR FRONT INDICATOR/ POSITION	BBPATCH-BT50.20  (INCLUDES X1 CABLE)		MY20 ONWARDS		

## HOLDEN COLORADO RG



**Important Note:**

Rear Patch Cable for the Holden Colorado RG will only work with the following rear tail lamps due to the Tail/Stop functions powered by one wire.



Suitable lamps:

- 82 Series
- 250 Series
- 275 Series
- 280 Series
- 282 Series
- 283 Series
- Maxilamp Series

Patch Application	Part No.	Picture	Notes	LTZ	Z71
 <p>PLUGGED REAR PATCH CABLE</p>	<p>PATCH-COLORADO (INCLUDES X2 CABLES WITH 12V RESISTOR)</p>		<p>ADVISE USE OF 2PM.5LP (LICENCE CAN TRIGGER CODE) SEE PAGE 9</p>	●	●
 <p>BULLBAR FRONT INDICATOR/ POSITION</p>	<p>BBPATCH-COLORADO (INCLUDES X2 CABLES)</p>		<p>LIGHTING SEE PAGE 12</p>	●	●
 <p>DRIVING LAMPS LIGHT BAR</p>	<p>DLPATCH-COLORADO (INCLUDES X1 CABLE)</p>		<p>SUITS ALL MODELS</p>	●	●

## HOLDEN RODEO







Patch Application	Part No.	Picture	Notes	MY03 - MY08
 <p>PLUGGED REAR PATCH CABLE</p>	<p>PATCH-DMAX (INCLUDES X2 CABLES)</p>		<p>LIGHTING SEE PAGE 6-9. SUITS MY03-MY08</p>	●







## GREAT WALL CANNON



Patch Application	Part No.	Picture	Notes	L	X
 PLUGGED REAR PATCH CABLE	PATCH-CANNON  (INCLUDES X2 CABLES)				







## GREAT WALL STEED



Patch Application	Part No.	Picture	Notes	4X2	4X4
 PLUGGED REAR PATCH CABLE	PATCH-STEEDSC  (INCLUDES X2 CABLES)		SUITS CAB CHASSIS		



## LDV T60/T70



Patch Application	Part No.	Picture	Notes	T60	T70
 PLUGGED REAR PATCH CABLE	PATCH-LDV  (INCLUDES X2 CABLES)		FITS T70 & T60 MODEL 2018 & 2019		
 DRIVING LAMPS LIGHT BAR	DLPATCH-LDVT60  (INCLUDES X1 CABLE)		SUITS LDVT60		

# ISUZU D-MAX RT/RG



Patch Application	Part No.	Picture	Notes	RT	RG
 PLUGGED REAR PATCH CABLE	PATCH-DMAX.UNI (INCLUDES X2 CABLES)		LIGHTING SEE PAGE 6-9		
 PLUGGED REAR PATCH CABLE	PATCH-DMAX (INCLUDES X2 CABLES)		LIGHTING SEE PAGE 6-9		
 BULLBAR FRONT INDICATOR/ POSITION	BBPATCH-DMAX (INCLUDES X2 CABLES)		RT PRE 2020 MODELS WITH LED HEADLIGHTS		
 BULLBAR FRONT INDICATOR/ POSITION	BBPATCH-DMAXH4 (INCLUDES X2 CABLES)		HALOGEN HEADLIGHT MODELS		
 BULLBAR FRONT INDICATOR/ POSITION	BBPATCH-DMAX.12 (INCLUDES X 2 CABLE)		MY12- MY17 LS- U/M/T WITH HALOGEN HEADLIGHTS		

# ISUZU D-MAX RT/RG



Patch Application	Part No.	Picture	Notes	RT	RG
 BULLBAR FRONT INDICATOR/ POSITION	BBPATCH-DMAXRG (INCLUDES X1 CABLE)		RG POST 2020 MODELS WITH LED HEADLIGHTS		
 DRIVING LAMPS LIGHT BAR	DLPATCH-DMAX (INCLUDES X1 CABLE)		RT PRE 2020 MODELS WITH LED HEADLIGHTS		
 DRIVING LAMPS LIGHT BAR	DLPATCH-DMAXRG (INCLUDES X1 CABLE)		RG POST 2020 MODELS WITH LED HEADLIGHTS		
 CAT5/6 SIDE INDICATOR LAMPS	77ACMB-DMAX (INCLUDES X1)		SEE PAGE 13 FOR 77 SERIES LAMP. SEE PAGE 15 FOR PIN CONFIGURATIONS		
 CAT5/6 SIDE INDICATOR LAMPS	77LC-LOOM (INCLUDES X1)		SEE PAGE 13 FOR 77 SERIES LAMP. SEE PAGE 15 FOR PIN CONFIGURATIONS		
 CAT5/6 SIDE INDICATOR LAMPS	77M-DMAX		SEE PAGE 17 FOR MORE INFORMATION		

# MITSUBISHI TRITON MN/MQ/MR



Patch Application	Part No.	Picture	Notes	MN	MQ	MR	MV
 PLUGGED REAR PATCH CABLE	PATCH-TRITONMN.UNI SUITS DUAL CAB (INCLUDES X2 CABLES)		TRAY CONVERSION OE PLUG TO BARE WIRES	●			
 PLUGGED REAR PATCH CABLE	PATCH-TRITONMQ.UNI SUITS DUAL CAB (INCLUDES X2 CABLES)		TRAY CONVERSION OE PLUG TO BARE WIRES		●		
 PLUGGED REAR PATCH CABLE	PATCH-TRITON-MN SUITS DUAL CAB (INCLUDES X2 CABLES)		CHECK IF DOUBLE OR SINGLE CAB	●			
 PLUGGED REAR PATCH CABLE	PATCH-TRITON-MNSC SUITS SINGLE CAB (INCLUDES X2 CABLES)		SINGLE CAB WORKS FROM 92 MODEL UPWARDS	●			
 PLUGGED REAR PATCH CABLE	PATCH-TRITON-MQ (INCLUDES X2 CABLES)		SUITS MQ/MR/ MV MODELS		●	●	●
 DRIVING LAMPS LIGHT BAR	DLPATCH-TRITONMR (INCLUDES X1 CABLE)		SUITS FACTORY HID/LED HEADLIGHTS			●	









# MITSUBISHI TRITON MN/MQ/MR



Patch Application	Part No.	Picture	Notes	MN	MQ	MR
 DRIVING LAMPS LIGHT BAR	DLPATCH-TRITONMQ (INCLUDES x1 CABLE)		SUITS FACTORY HID/LED HEADLIGHTS			
 BULLBAR FRONT INDICATOR/ POSITION	BBPATCH-TRITONMR (INCLUDES x2 CABLES)		SUITS FACTORY HID/LED HEADLIGHTS			
 BULLBAR FRONT INDICATOR/ POSITION	BBPATCH-TRITONMQ (INCLUDES x2 CABLES)		SUITS FACTORY LED HEADLIGHTS SEE PAGE 13			
 BULLBAR FRONT INDICATOR/ POSITION	BBPATCH-TRITONMQ.NL (INCLUDES x2 CABLES)		SUITS HALOGEN HEADLIGHTS SEE PAGE 13			

# MITSUBISHI PAJERO QE/QF



Patch Application	Part No.	Picture	Notes	QE	QF
 DRIVING LAMPS LIGHT BAR	DLPATCH-PAJEROQE (INCLUDES x1 CABLE)		TO SUIT QE MODELS WITH FACTORY LED HEADLIGHTS		
 DRIVING LAMPS LIGHT BAR	DLPATCH-PAJEROQF (INCLUDES x1 CABLE)		TO SUIT QF MODELS WITH FACTORY LED HEADLIGHTS		

# NISSAN NAVARA NP300



**Important Note Regarding Tail Lamp Patch:**

Please check vehicle build country before ordering rear lamp patch lead as plugs are different between the Thai and Spanish built models.

Ensure you visually match the plugs before ordering.

Patch Application	Part No.	Picture	Notes	Dual Cab	Cab Chassis
 PLUGGED REAR PATCH CABLE	PATCH-NAVARANP.UNI (INCLUDES X2 CABLES)		TO SUIT THAI MODEL	<input checked="" type="checkbox"/>	<input type="checkbox"/>
 PLUGGED REAR PATCH CABLE	PATCH-NAVARAT-NP300 (INCLUDES X2 CABLES)		TO SUIT THAI MODEL	<input checked="" type="checkbox"/>	<input type="checkbox"/>
 PLUGGED REAR PATCH CABLE	PATCH-NP300CC (INCLUDES X2 CABLES)		*FACTORY CAB CHASSIS TO SUIT THAI MODEL, MAY NEED LR ON REV.	<input type="checkbox"/>	<input checked="" type="checkbox"/>
 BULLBAR FRONT INDICATOR/ POSITION	BBPATCH-NAVARA (INCLUDES X2 CABLES)		SUIT FACTORY LED HEADLIGHTS  LIGHTING SEE PAGE 12	<input checked="" type="checkbox"/>	<input checked="" type="checkbox"/>
 BULLBAR FRONT INDICATOR/ POSITION	BBPATCH-NAVARA.DRL (INCLUDES X2 CABLES)		AMP PLUG TO OE PLUGS, WITH DRL CONNECTORS LIGHTING SEE PAGE 12	<input checked="" type="checkbox"/>	<input checked="" type="checkbox"/>
 DRIVING LAMPS LIGHT BAR	DLPATCH-NAVARA (INCLUDES X1 CABLE)		WARNING MUST BE FITTED BY AUTO ELECTRICIAN DAMAGE MAY OCCUR. SUITS FACTORY LED LIGHTS	<input checked="" type="checkbox"/>	<input checked="" type="checkbox"/>

# NISSAN PATROL



Patch Application	Part No.	Picture	Notes	GU	Y62
 <p>CAT5/6 SIDE INDICATOR LAMPS</p>	<p>77AMB-LCRUISER70 (INCLUDES x1 CABLE)</p>		<p>DIRECT FIT, PATCH LEAD NOT REQUIRED</p>		
 <p>CAT5/6 SIDE INDICATOR LAMPS</p>	<p>77ACMB-LCRUISER70 (INCLUDES x1 CABLE)</p>		<p>DIRECT FIT, PATCH LEAD NOT REQUIRED</p>		
 <p>DRIVING LAMPS LIGHT BAR</p>	<p>DLPATCH-PATROLY62 (INCLUDES x1 CABLE)</p>		<p>SUITS Y62 SERIES 5 ONLY</p>		

# TOYOTA LANDCRUISER























Patch Application	Part No.	Picture	Notes	7X	200	300
 PLUGGED REAR PATCH CABLE	PATCH-LCRUISER.UNI  (INCLUDES x2 CABLES)		OE PLUG TO BARE WIRES			
 PLUGGED REAR PATCH CABLE	PATCH-LCRUISER  (INCLUDES x2 CABLES)		LIGHTING SEE PAGE 6-9			
 PLUGGED REAR PATCH CABLE	PATCH-EXTCRUISE  (INCLUDES x2 CABLES)		USED TO EXTEND THE FACTORY LOOM OR O/E LIGHTING			
 PLUGGED REAR PATCH CABLE	PATCH- EXTCRUISELR1M  (INCLUDES x2 CABLES)		USED TO EXTEND THE FACTORY LOOM OR O/E LIGHTING			
 PLUGGED REAR PATCH CABLE	LC300REVKIT  (INCLUDES CABLE/ LAMP/BRACKET)		REVERSE LAMP/ ADAPTER PATCH CABLE AND ALLOY BRACKET SEE PAGE 9			
 BULLBAR FRONT INDICATOR/ POSITION	BBPATCH-LC7X  (INCLUDES x2 CABLES)					
 BULLBAR FRONT INDICATOR/ POSITION	BBPATCH-79RADAR  (INCLUDES x1 CABLE)		LANDCRUISER 79 SERIES FRONT RADAR EXTENSION PATCH CABLE			
 BULLBAR FRONT INDICATOR/ POSITION	BBPATCH-LC30022-A  (INCLUDES x2 CABLE)		BULLBAR CONV. KIT - LC300			









# TOYOTA LANDCRUISER



Patch Application	Part No.	Picture	Notes	7X	200	300
 DRIVING LAMPS LIGHT BAR	DLPATCH-LCRUISER (INCLUDES X1 CABLE)					
 CAT5/6 SIDE INDICATOR LAMPS	77AMB-LCRUISER70 (INCLUDES X1 CABLE)		DIRECT FIT, PATCH LEAD NOT REQUIRED			
 CAT5/6 SIDE INDICATOR LAMPS	77ACMB-LCRUISER70 (INCLUDES X1 CABLE)		DIRECT FIT, PATCH LEAD NOT REQUIRED			
 CAT5/6 SIDE INDICATOR LAMPS	77AMB-LCRUISER200 (INCLUDES X1 CABLE)					
 CAT5/6 SIDE INDICATOR LAMPS	77ACMB-LCSAHARA (INCLUDES X1 CABLE)					
 CAT5/6 SIDE INDICATOR LAMPS	77ACM-LCR7021 (INCLUDES X1 CABLE)		CAT6 INDICATOR 21W LOAD RESISTOR			
 CAT5/6 SIDE INDICATOR LAMPS	77ACMB-LC30022/2KIT (INCLUDES X2 CABLE)		CAT6 FOR LC30022 PAIR KIT MY22			







# TOYOTA HILUX



Patch Application	Part No.	Picture	Notes	MY15+	MY20+
 PLUGGED REAR PATCH CABLE	PATCH-HILUX.UNI (INCLUDES x2 CABLES)		TRAY CONVERSION OE PLUG TO BARE WIRES		
 PLUGGED REAR PATCH CABLE	PATCH-HILUX (INCLUDES x2 CABLES)		MAY REQUIRE A COMPUTER RESET		
 BULLBAR FRONT INDICATOR/ POSITION	BBPATCH-HILUX (INCLUDES x2 CABLES)		LED HEADLIGHTS		
 BULLBAR FRONT INDICATOR/ POSITION	BBPATCH-HILUXH4 (INCLUDES x2 CABLES)		HALOGEN HEADLIGHTS		
 BULLBAR FRONT INDICATOR/ POSITION	BBPATCH-HILUXN80 (INCLUDES x2 CABLES)		SUITS LED HEADLIGHTS		
 CAT5/6 SIDE INDICATOR LAMPS	77LC-L00M (INCLUDES x1 CABLE)		SEE PAGE 13 FOR 77 SERIES LAMPS		
 DRIVING LAMPS LIGHT BAR	DLPATCH-HILUXN80 (INCLUDES x1 CABLE)		SUITS LED HEADLIGHT MODELS		



## TOYOTA HIACE



Patch Application	Part No.	Picture	Notes	HiAce
 CAT5/6 SIDE INDICATOR LAMPS	77LC-L00M (INCLUDES x1 CABLE)		SEE PAGE 13 FOR 77 SERIES LAMPS	
 CAT5/6 SIDE INDICATOR LAMPS	77ACMB-HIACE300 (77ACMB-LCSAHARA) (INCLUDES x1 CABLE)			







## TOYOTA PRADO 150



Patch Application	Part No.	Picture	Notes	MY13+	MY22
 BULLBAR FRONT INDICATOR/ POSITION	BBPATCH-LC7X (INCLUDES x2 CABLES)		LIGHTING SEE PAGE 13		

## TOYOTA FORTUNER



Patch Application	Part No.	Picture	Notes	MY15+	MY21+
 DRIVING LAMPS LIGHT BAR	DLPATCH-FORTUNER15 (INCLUDES x1 CABLE)				
 DRIVING LAMPS LIGHT BAR	DLPATCH-FORTUNER21 (INCLUDES x1 CABLE)				

# FORD RANGER/RAPTOR/ EVEREST (PX2/PX3)



Patch Application	Part No.	Picture	Notes	Ranger	Ranger MY22	Raptor
 <p>BULLBAR FRONT INDICATOR/ POSITION</p>	BBPATCH-RANGER (INCLUDES X2 CABLES)		LIGHTING SEE PAGE 13 ALSO SUITS EVEREST	●		●
 <p>BULLBAR FRONT INDICATOR/ POSITION</p>	BBPATCH-RANGER22 (INCLUDES X2 CABLES)		LIGHTING SEE PAGE 13 ALSO SUITS EVEREST		●	
 <p>DRIVING LAMPS/ LIGHT BAR</p>	DLPATCH-RANGER (INCLUDES X1 CABLE)		SUITS ALL MODELS ALSO SUITS EVEREST	●		●
 <p>DRIVING LAMPS/ LIGHT BAR</p>	DLPATCH-RANGER22 (INCLUDES X1 CABLE)		SUITS RANGER22 (2 PIN QC PLUG)		●	
 <p>DRIVING LAMPS/ LIGHT BAR</p>	DLPATCH-RANGER22.1 (INCLUDES X1 CABLE)		SUITS RANGER22 (2 PIN DT PLUG)		●	



## FORD RANGER/RAPTOR/ EVEREST (PX2/PX3)



Patch Application	Part No.	Picture	Notes	Ranger	Ranger MY22	Raptor
 CAT5/6 SIDE INDICATOR LAMPS	77ACMB-RANGER (INCLUDES X1 BBIPATCH-RANGER & X1 77ACM-3AMP)		SUITS ALL MODELS ALSO SUITS EVEREST	●		●
 CAT5/6 SIDE INDICATOR LAMPS	77ACMB-RANGER22 (INCLUDES X1 BBPATCH-RANGER22 & X1 77ACM-3AMP)				●	
 CAT5/6 SIDE INDICATOR LAMPS	77M-RANGER MAGNETIC TEMPLATE FITTING GUIDE		SEE PAGE 17 FOR MORE INFORMATION	●		
 CAT5/6 SIDE INDICATOR LAMPS	77M-RANGER22 MAGNETIC TEMPLATE FITTING GUIDE		SEE PAGE 17 FOR MORE INFORMATION		●	

## FORD F150 LARIAT



Patch Application	Part No.	Picture	Notes	LARIAT
 BULLBAR FRONT INDICATOR/ POSITION	CAT6PATCH-RANGER22 (INCLUDES X2 CABLES)		CAT6 BREAKOUT PATCH LEAD SEE PAGE 13 FOR MORE INFORMATION	●

## FORD RANGER/RAPTOR/ EVEREST (PX2/PX3)



Patch Application	Part No.	Picture	Notes	Ranger	Ranger MY22	Raptor
 PLUGGED REAR PATCH CABLE	PATCH-RANGERBT50.UNI (INCLUDES X2 CABLES)		ALSO SUITS EVEREST			
 PLUGGED REAR PATCH CABLE	PATCH-RANGERBT50 (INCLUDES X2 CABLES)		LIGHTING SEE PAGE 6-9 SUITS NEXT GEN RANGER CAB CHASSIS			
 PLUGGED REAR PATCH CABLE	PATCH-RANGER22 (INCLUDES X2 CABLES)		SUITS NON- SEQUENTIAL TAIL LIGHTS.(EXCEPT MAXILAMP USE PATCH- RANGER22.1)INCLUDES BLIND SPOT RADAR PLUG. SEE BELOW.			
 PLUGGED REAR PATCH CABLE	2PMLP-RANGER22		LICENCE PLUG REAR PATCH CABLE FOR RANGER22. SEE BELOW.			

## 2022+ NEXT GEN FORD RANGER REAR PATCH HARNESS WITH BLIND SPOT INFORMATION SYSTEM (BLIS®) RELOCATION PLUG EXTENSIONS



### P/N: PATCH-RANGER22

STOP/TAIL/INDICATOR  
REVERSE. SUITS NON-  
SEQUENTIAL TAIL LIGHTS  
WITH BLIND SPOT RADAR  
PLUG.



### P/N: 2PMLP-RANGER22

LICENCE PLATE LAMP  
PLUG FOR RANGER22.  
INCLUDES 2 CORE MOLEX  
AND CSB PLUGS WITH  
300MM OF CABLE.

LEFT HAND SIDE (PASSENGER)

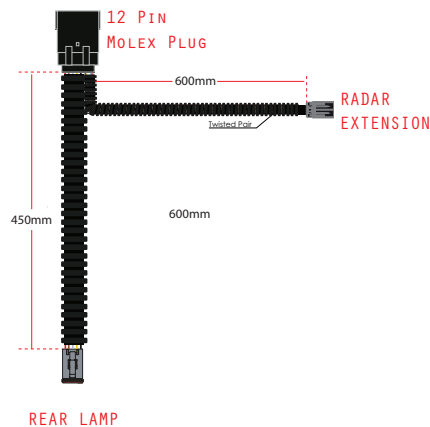

RIGHT HAND SIDE (DRIVER)

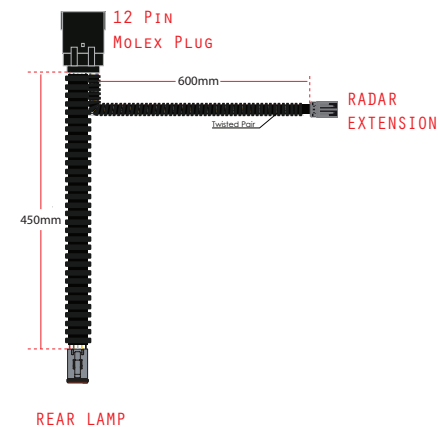

# FORD RANGER/RAPTOR/ EVEREST (PX2/PX3)



Patch Application	Part No.	Picture	Notes	Ranger	Ranger MY22	Raptor
 PLUGGED REAR PATCH CABLE	PATCH-RAPTOR (INCLUDES X2 CABLES)		LIGHTING SEE PAGE 6-9			
 PLUGGED REAR PATCH CABLE	PATCH-RANGER22.1		SUITS SEQUENTIAL (AND NON-SEQUENTIAL) TAIL LIGHTS. MAY REQUIRE PATCH-RELAY. INCLUDES BLIND SPOT RADAR PLUG AND RESISTORS. SEE BELOW.			
 PLUGGED REAR PATCH CABLE	PATCH-RELAY (INCLUDES X2 CABLES)		4-PIN RELAY WITH 450MM CABLE AND DT04-4P PLUG. SEE BELOW.			
 PLUGGED REAR PATCH CABLE	BJB4RELAY		RELAY PATCH WITH 12 PIN B4 PLUG + SOCKET. (RANGER22 SEQUENTIAL IND ISSUE FIX)			

## 2022+ NEXT GEN FORD RANGER REAR PATCH HARNESS WITH BLIND SPOT INFORMATION SYSTEM (BLIS®) RELOCATION PLUG EXTENSIONS



### P/N: PATCH-RANGER22.1

STOP/TAIL/SEQUENTIAL INDICATOR AND REVERSE. SUITS SEQUENTIAL TAIL LIGHTS WITH BLIND SPOT RADAR PLUG AND RESISTORS.



### P/N: PATCH-RELAY

4-PIN RELAY MAYBE REQUIRED WITH THE PATCH-RANGER22.1

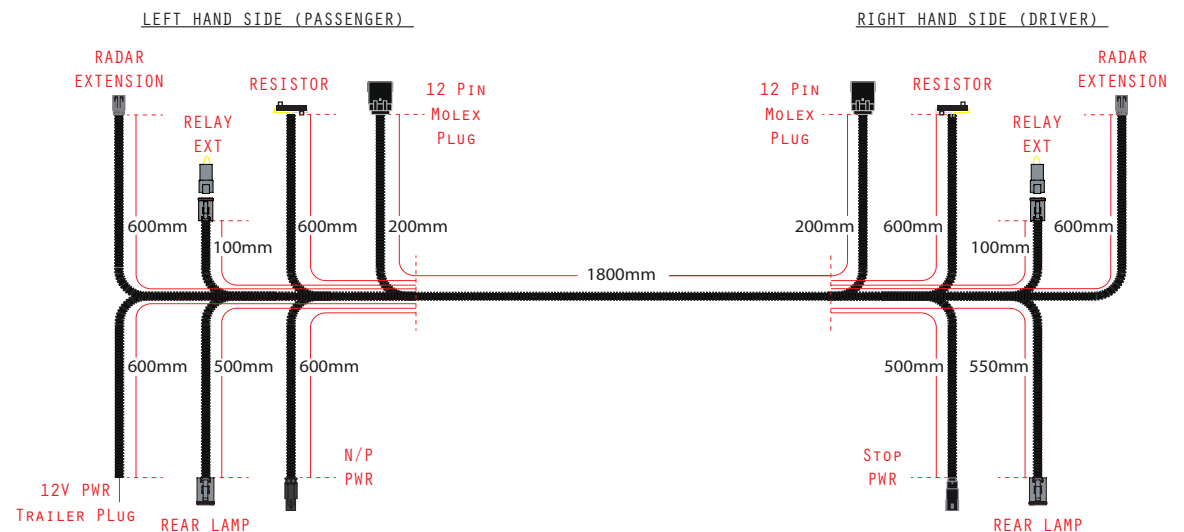



## JEEP GRAND CHEROKEE



Patch Application	Part No.	Picture	Notes	WK2
 DRIVING LAMPS LIGHT BAR	DLPATCH-GCHEROKEE  (INCLUDES x1 CABLE)		FITS WK2 MODELS WITH LED/HID HEADLIGHTS	



## JEEP WRANGLER/GLADIATOR



Patch Application	Part No.	Picture	Notes	JL / JT
 DRIVING LAMPS LIGHT BAR	DLPATCH-WRANGLER  (INCLUDES x1 CABLE)		SUITS JL WRANGLER/JT GLADIATOR	



## SUZUKI JIMNY



Patch Application	Part No.	Picture	Notes	MY18+
 DRIVING LAMPS LIGHT BAR	DLPATCH-JIMNY  (INCLUDES x1 CABLE)		SUITS 2018 ONWARDS	





## SSANGYONG MUSSO



Patch Application	Part No.	Picture	Notes	Musso
 PLUGGED REAR PATCH CABLE	PATCH-MUSSO  (INCLUDES x2 CABLES)		LP CAN TRIGGER CODE IF NOT USED. WE ADVISE USE OF PART NO. 2PM.5LP SEE PAGE 11	

## MAHINDRA S6+ / S10+



Patch Application	Part No.	Picture	Notes	S6+	S10+
 PLUGGED REAR PATCH CABLE	PATCH-MAHINDRA  (INCLUDES x2 CABLES)		LIGHTING SEE PAGE 6-9		



# VOLKSWAGEN AMAROK



Patch Application	Part No.	Picture	Notes	Amarok
 <p>PLUGGED REAR PATCH CABLE</p>	PATCH-AMAROK.UNI (INCLUDES X2 CABLES)		TRAY CONVERSION OE PLUG TO BARE WIRES	
 <p>PLUGGED REAR PATCH CABLE</p>	PATCH-AMAROK5LR (INCLUDES X2 CABLES)		USE PART NO.2PM.5LP IF REPLACING LICENCE PLATE SEE PAGE 11	
 <p>PLUGGED REAR PATCH CABLE</p>	PATCH-AMAROK23 (INCLUDES X2 CABLES)		SUITS MY23	
 <p>BULLBAR FRONT INDICATOR/ POSITION</p>	BBPATCH-AMAROK (INCLUDES X2 CABLES)		LIGHTING SEE PAGE 13	
 <p>DRIVING LAMPS LIGHT BAR</p>	DLPATCH-AMAROK (INCLUDES X1 CABLE)			



## Rigid Body Harnessing System

Our research and development team continually adapt to keep up with as many vehicles as possible. The Rigid Body trucks can also benefit from this system with many possibilities to streamline your lighting and wiring options. We now offer a Power Harness that taps into the vehicles' existing harness loom, enabling fitment of our Rigid Body cable, marker kits, and accessories without time-consuming wiring. This innovative system will give you the flexibility and adaptability to compliment your O/E fitting requirements saving you time and money.

As simple as adding a trailer plug or a complete harness and lighting solution, our power harness will make ordering easy and add to your bottom line.

### Compatible with the following brands

- Suits Hino
- Suits Isuzu
- Suits Mitsubishi
- Suits Hyundai
- Suits Fuso
- Suits Iveco
- Suits Nissan UD

### Evolving Brand Compatibility

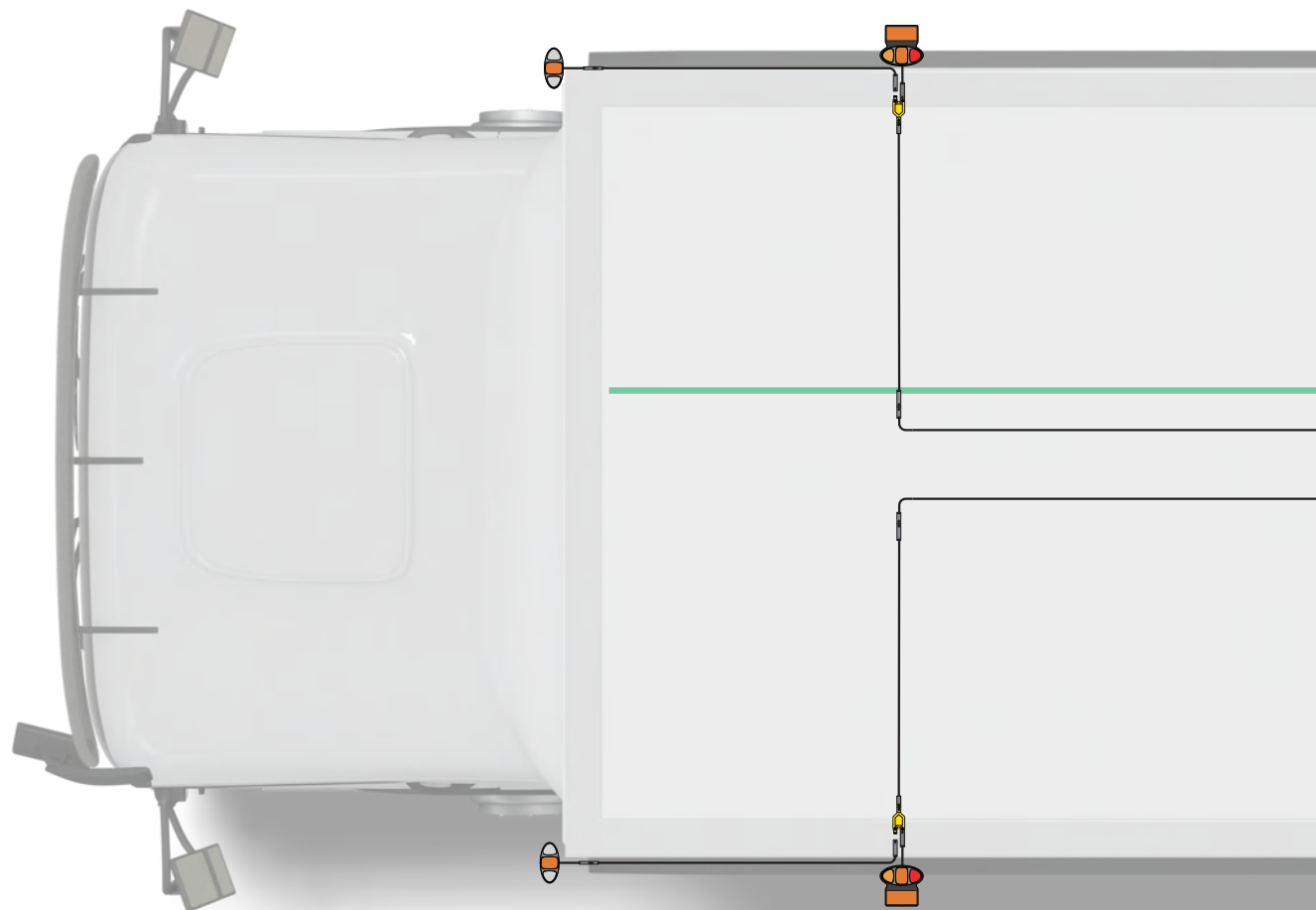

MAIN LOOM



## Rigid Body Kits - Patch Into Existing Wiring Loom

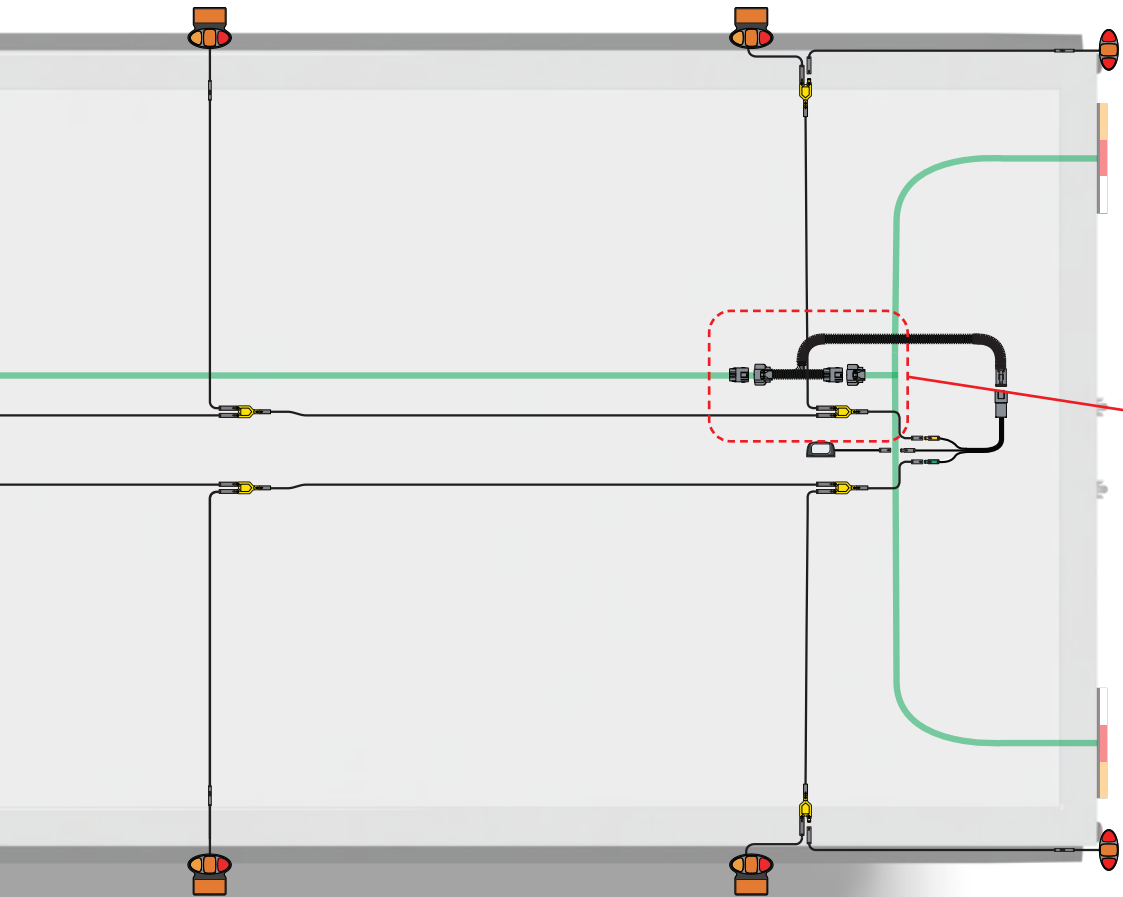

It has never been easier to tap into the vehicles' existing loom by using our innovative Patch System.

- Perfect for OEM Fitters
- Save Time & Money
- System Expandable
- System Customisable
- System Adaptability

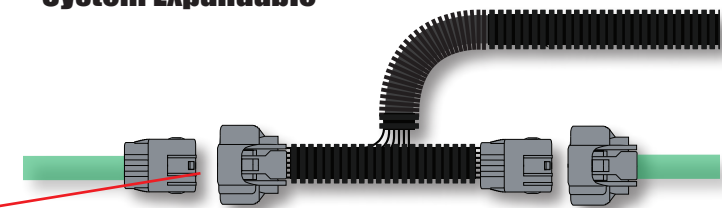

PATCHING INTO THE EXISTING LOOM USING A PPATCH POWER HARNESS

### Multiple Cable Lengths to Choose From



Part No.	Length
2PMF.25B	25 CENTIMETERS
2PMF.5B	50 CENTIMETERS
2PMF1B	1 METRE
2PMF1.5B	1.5 METRE
2PMF2B	2 METRE
2PMF2.5B	2.5 METRE
2PMF3B	3 METRE
2PMF4B	4 METRE
2PMF5B	5 METRE



Part No.	Length
3PMF.2B	20 CENTIMETERS
3PMF.5B	50 CENTIMETERS
3PMF1B	1 METRE
3PMF2B	2 METRE
3PMF3B	3 METRE
3PMF4B	4 METRE
3PMF5B	5 METRE

See Pages 56-59 for Accessories

### Rigid Body Add-on Kits

Part No.	Description
RBK-ADD.RM	RBK - BASE KIT ADD-ON, REAR MARKERS (42RM)
RBK-ADD.SM	RBK - BASE KIT ADD-ON, SIDE MARKERS (42ARM), 2.5M 2C EXT.
RBK-SB	RBK - SMALL BASE KIT, 4x 42ARM, 2x 42WM

# Rigid Body Kits - 4 to 6 Metre TRAY

## P/N: RBK-413

SUITS: TRAY 4-6M  
 LAMPS: 42 SERIES  
 WIRE CORE: 2/3 CORE

PART No.	QTY
42ARMCSB	4
42AMCSB	4
3P3IMB	2
3PMF.2B	2
3PMF2B	2
3PMF3B	2
3PMF5B	2
PPATCH-RBK3C	1
3PFTIB	4

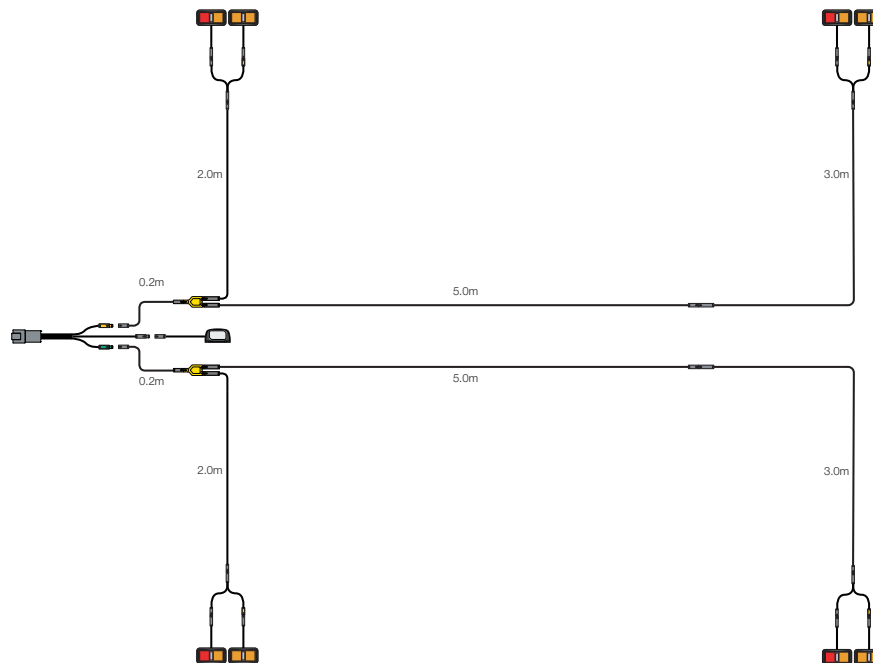

**RBK-413 USES**  
42 SERIES LAMPS

## P/N: RBK-412

SUITS: TRAY 4-6M  
 LAMPS: 97 SERIES  
 WIRE CORE: 3 CORE

PART No.	QTY
97CARIMCSB	4
97BKT	4
7CILR3B	1
3P3IMB	2
3PMF.2B	2
3PMF2B	2
3PMF3B	2
3PMF5B	2
PPATCH-RBK3C	1

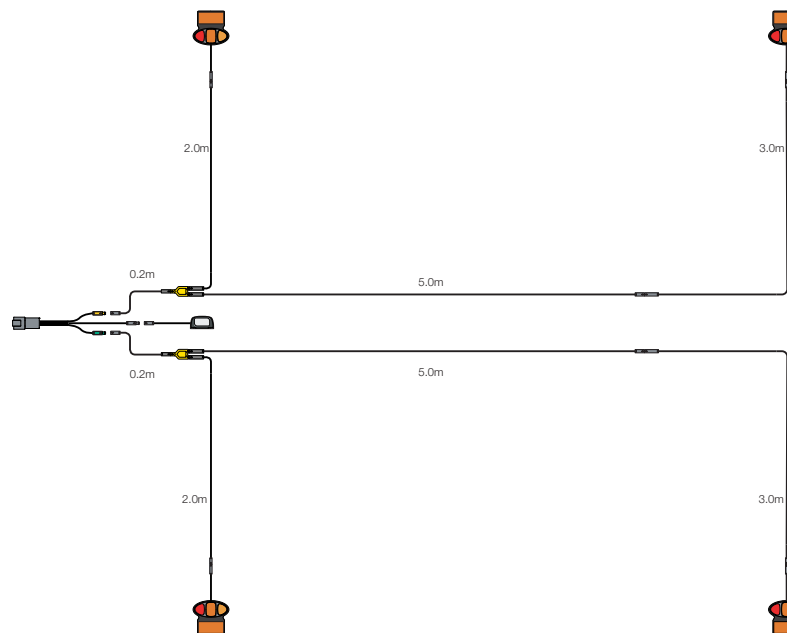

**RBK-412 USES**  
97 SERIES LAMPS



# Rigid Body Kits - 4 to 6 Metre VAN



## P/N: RBK-423

SUITS:VAN 4-6M  
LAMPS:42 SERIES  
WIRE CORE: 2/3 CORE

PART No.	QTY
42ARMCSB	4
42AMCSB	4
42WMCSB	2
42RMCSB	2
3P3IMB	2
2P3WB	4
2PCB	4
3PMF2B	2
3PMF3B	2
3PMF.2B	2
3PMF5B	2
2PMF5B	4
PPATCH-RBK3C	1
3PFTIB	4

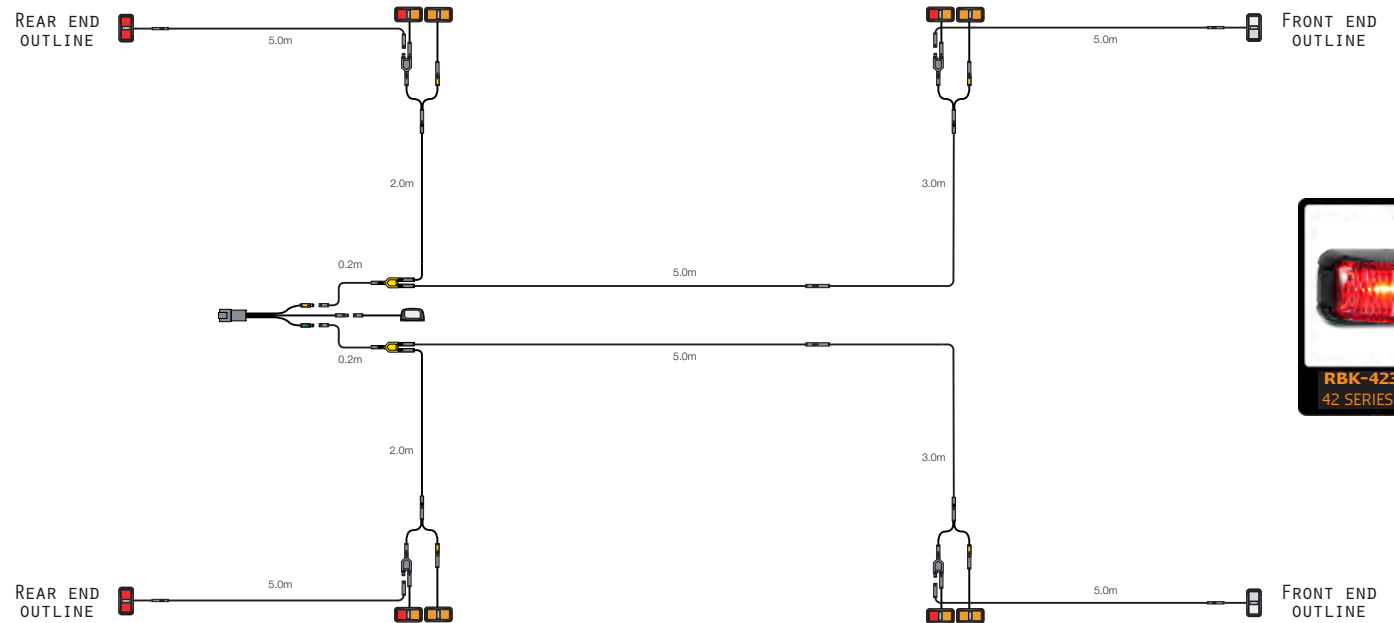

## P/N: RBK-422

SUITS:VAN 4-6M  
LAMPS:97 SERIES  
WIRE CORE: 3 CORE

PART No.	QTY
97CARIMCSB	4
97CRIMCSB	2
97CWIMCSB	2
97BKT	4
3P3IMB	6
2PCB	4
3PMF5B	6
3PMF2B	2
3PMF3B	2
3PMF.2B	2
PPATCH-RBK3C	1

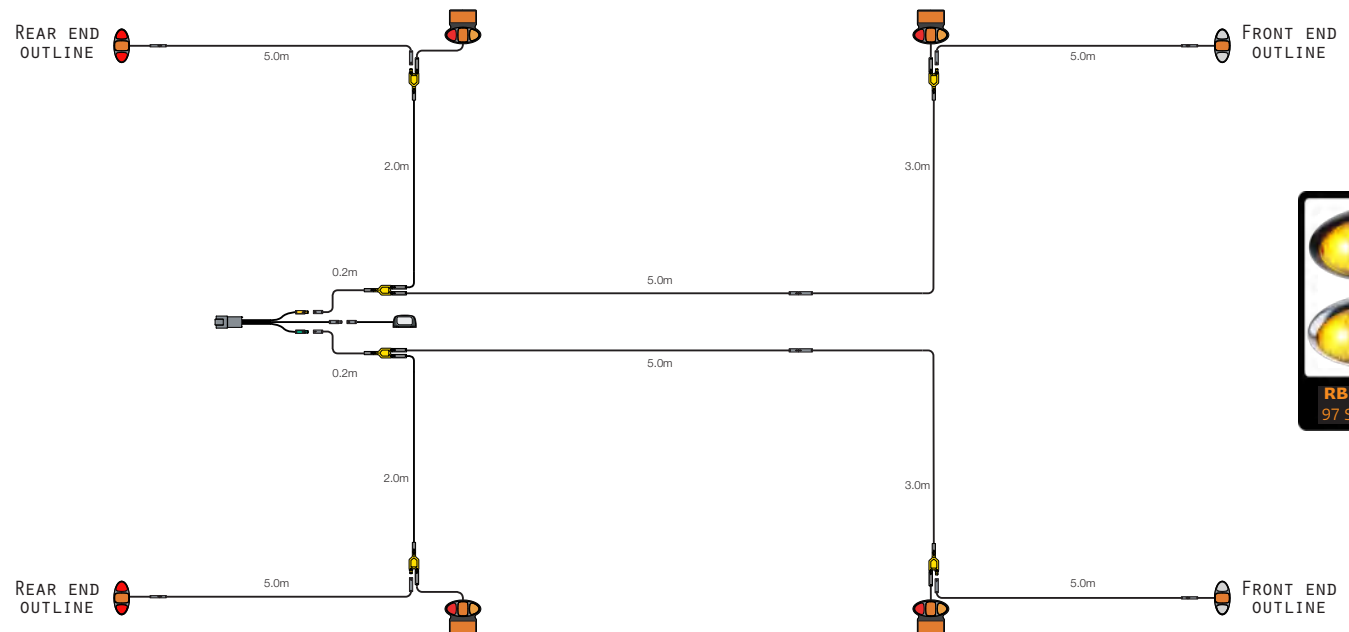

# Rigid Body Kits - 6 to 9 Metre TRAY

## P/N: RBK-613

SUITS: TRAY 6-9M  
 LAMPS: 42 SERIES  
 WIRE CORE: 2/3 CORE

PART No.	QTY
42ARMCSB	6
42AMCSB	6
3P3IMB	4
3PMF2B	6
3PMF4B	2
3PMF.2B	2
PPATCH-RBK3C	1
3PFTIB	6

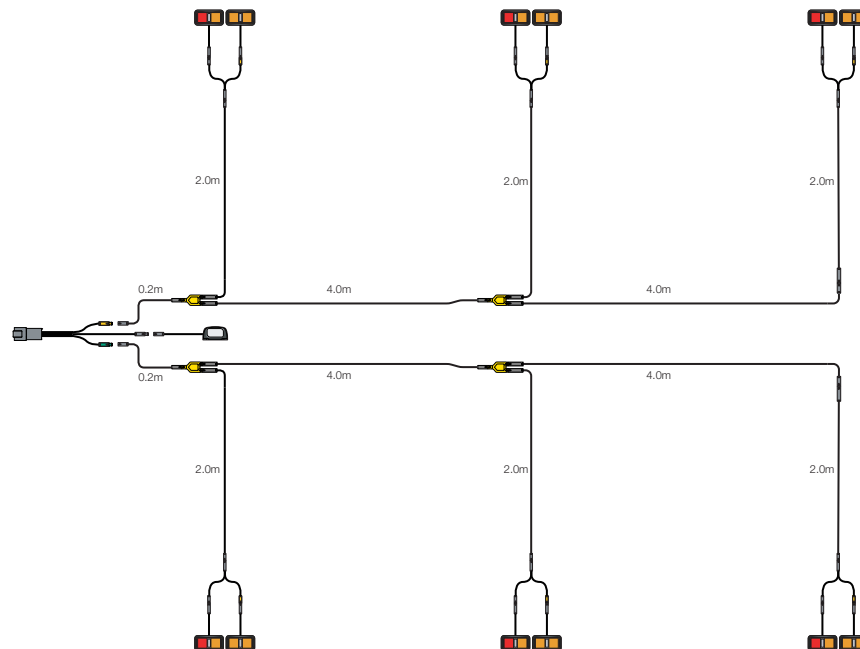

## P/N: RBK-612

SUITS: TRAY 6-9M  
 LAMPS: 97 SERIES  
 WIRE CORE: 3 CORE

PART No.	QTY
97CARIMCSB	6
97BKT	6
3P3IMB	4
3PMF2B	6
3PMF4B	4
3PMF.2B	2
PPATCH-RBK3C	1

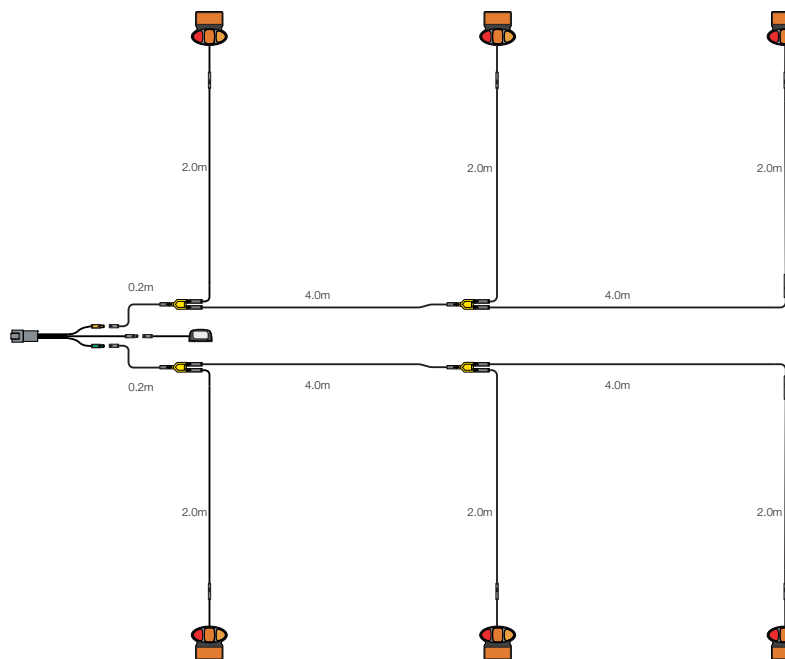

# Rigid Body Kits - 6 to 9 Metre VAN



## P/N: RBK-623

SUITS: VAN 6-9M  
 LAMPS: 42 SERIES  
 WIRE CORE: 2/3 CORE

PART NO.	QTY
42ARMCSB	6
42AMCSB	6
42WMCSB	2
42RMCSB	2
3P3IMB	4
2P3WB	4
2PCB	4
3PMF4B	4
3PMF2B	6
3PMF.2B	2
2PMF5B	4
PPATCH-RBKT3C	1
3PFTIB	6

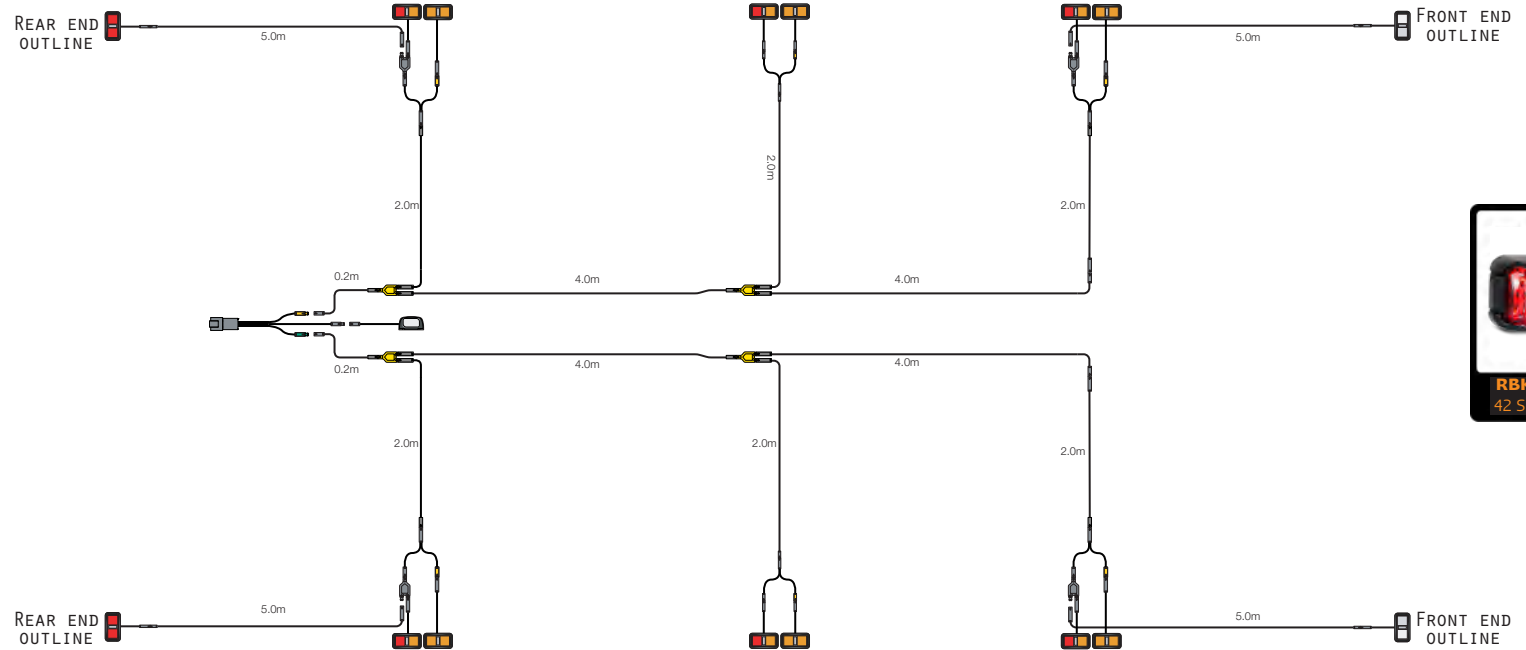

## P/N: RBK-622

SUITS: VAN 6-9M  
 LAMPS: 97 SERIES  
 WIRE CORE: 3 CORE

PART NO.	QTY
97CARIMCSB	6
97CRIMCSB	2
97CWIMCSB	2
97BKT	6
3P3IMB	8
2PCB	4
3PMF5B	4
3PMF4B	4
3PMF2B	6
3PMF.2B	2
PPATCH-RBK3C	1

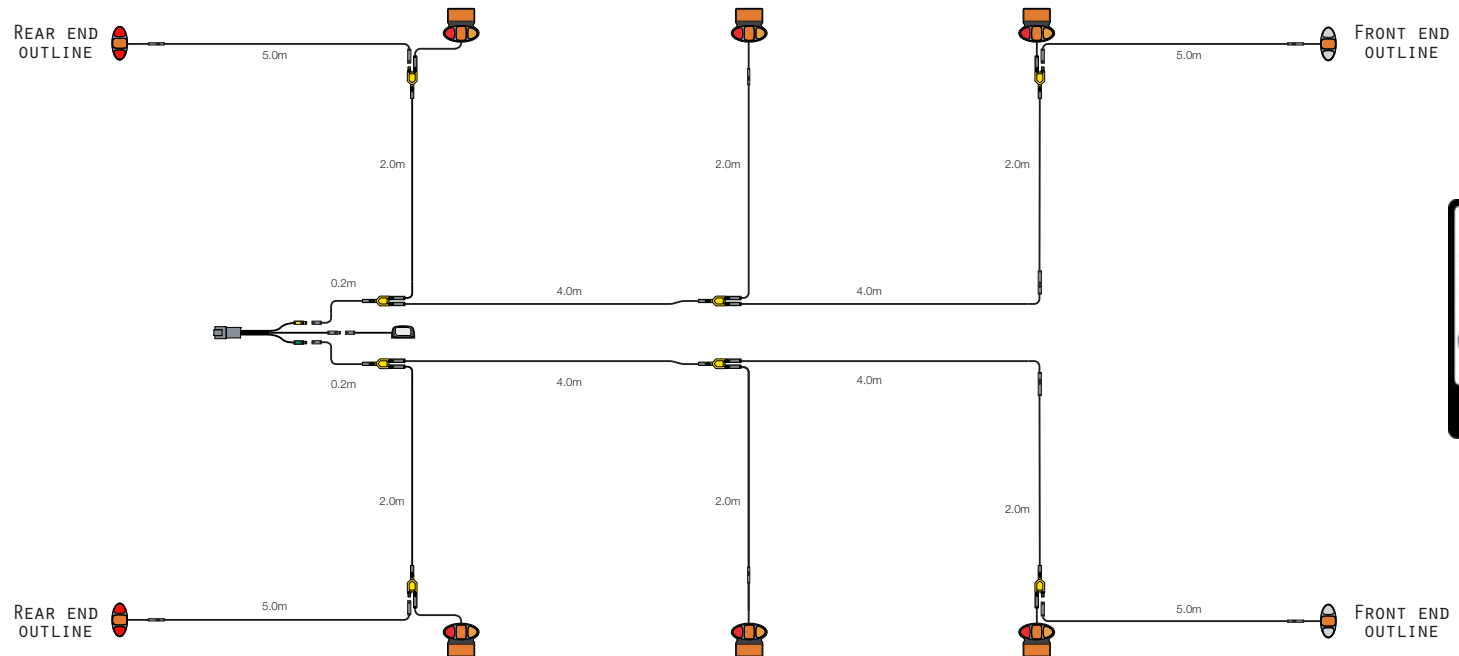

# Rigid Body Kits - 10 to 12 Metre TRAY

## P/N: RBK-1013

SUITS: TRAY 10-12M  
 LAMPS: 42 SERIES  
 WIRE CORE: 2/3 CORE

PART NO.	QTY
42ARMCSB	8
42AMCSB	8
3P3IMB	6
3PMF2B	8
3PMF4B	6
3PMF.2B	2
PPATCH-RBK3C	1
3PFTIB	8

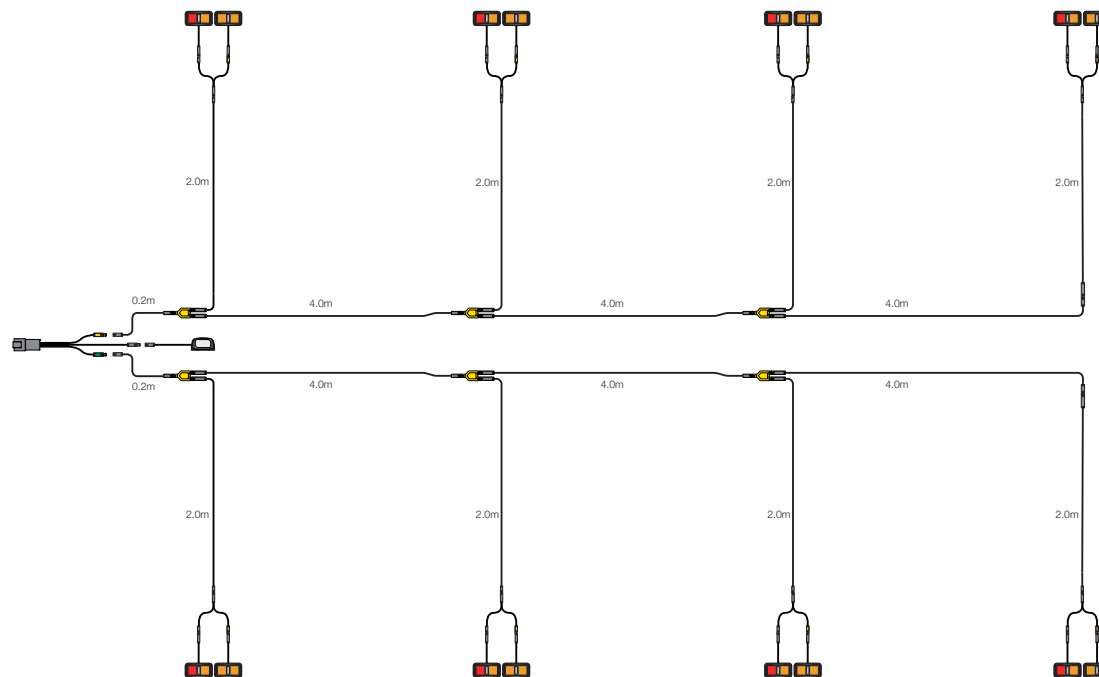

## P/N: RBK-1012

SUITS: TRAY 10-12M  
 LAMPS: 97 SERIES  
 WIRE CORE: 3 CORE

PART NO.	QTY
97CARIMCSB	8
97BKT	8
3P3IMB	6
3PMF2B	8
3PMF4B	6
3PMF.2B	2
PPATCH-RBK3C	1

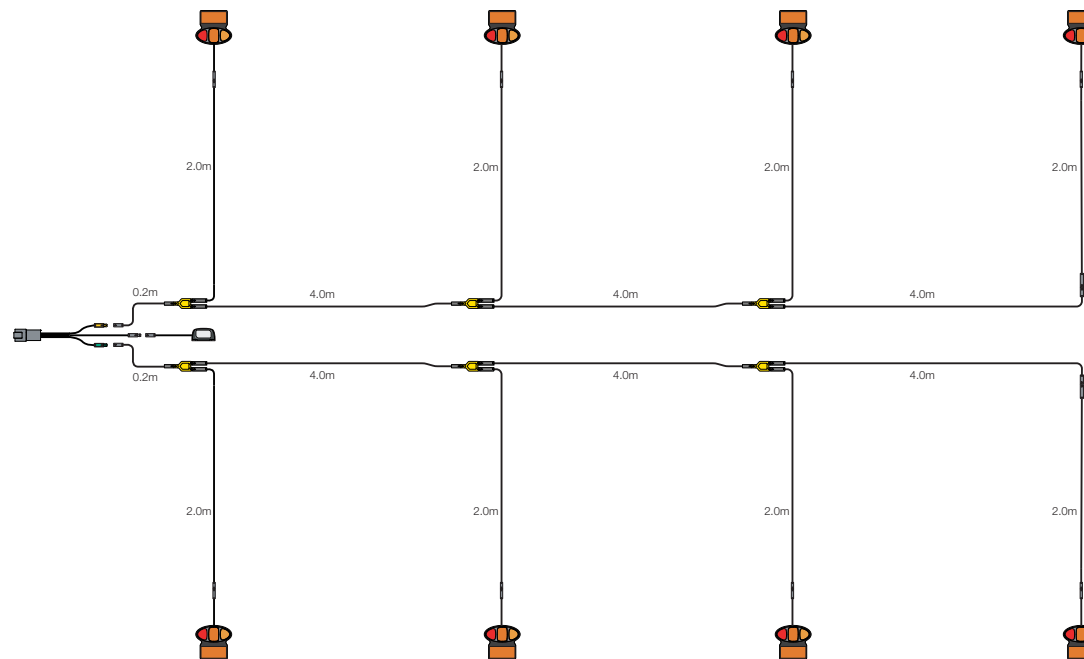



# Rigid Body Kits - 10 to 12 Metre VAN

## P/N: RBK-1023

SUITS: VAN 10-12M  
 LAMPS: 42 SERIES  
 WIRE CORE: 2/3 CORE

PART No.	QTY
42ARMCSB	8
42AMCSB	8
42WMCSB	2
42RMCSB	2
3P3IMB	6
2P3WB	4
2PCB	4
3PMF2B	8
3PMF4B	6
3PMF.2B	4
2PMF5B	4
PPATCH-RBK3C	1
3PFTIB	8

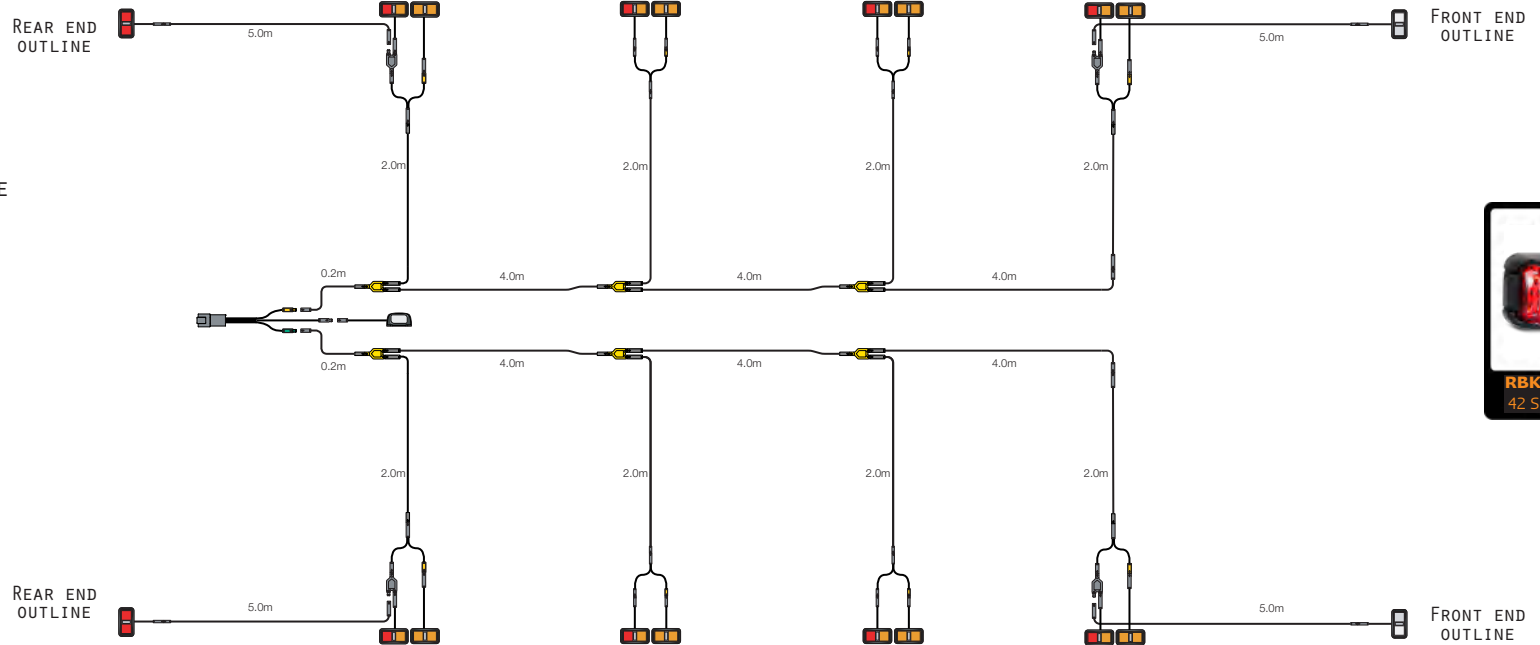

## P/N: RBK-1022

SUITS: VAN 10-12M  
 LAMPS: 97 SERIES  
 WIRE CORE: 3 CORE

PART No.	QTY
97CARIMCSB	8
97CRIMCSB	2
97CWIMCSB	2
97BKT	8
3P3IMB	10
2PCB	4
3PMF5B	4
3PMF2B	8
3PMF4B	2
3PMF.2B	2
PPATCH-RBK3C	1

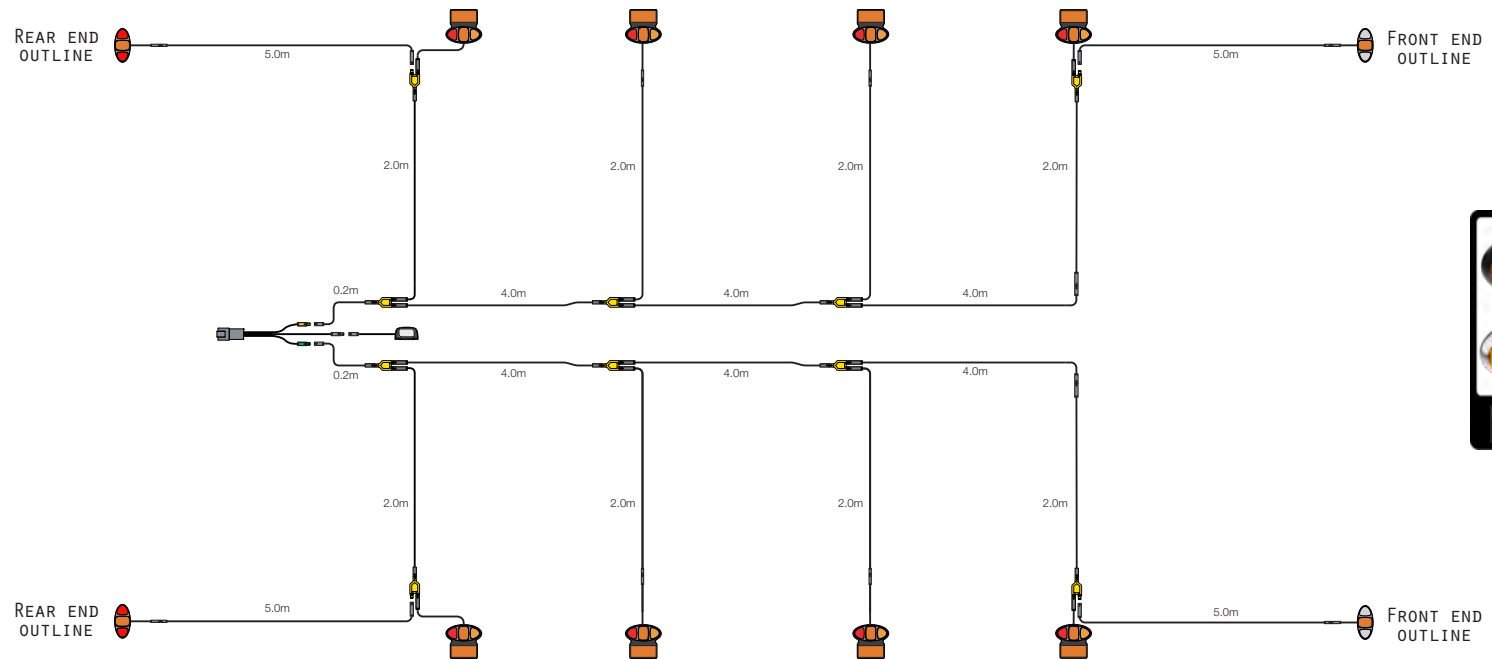



## Rigid Body Kits - Break Out Patches for High Level Rear Lamps

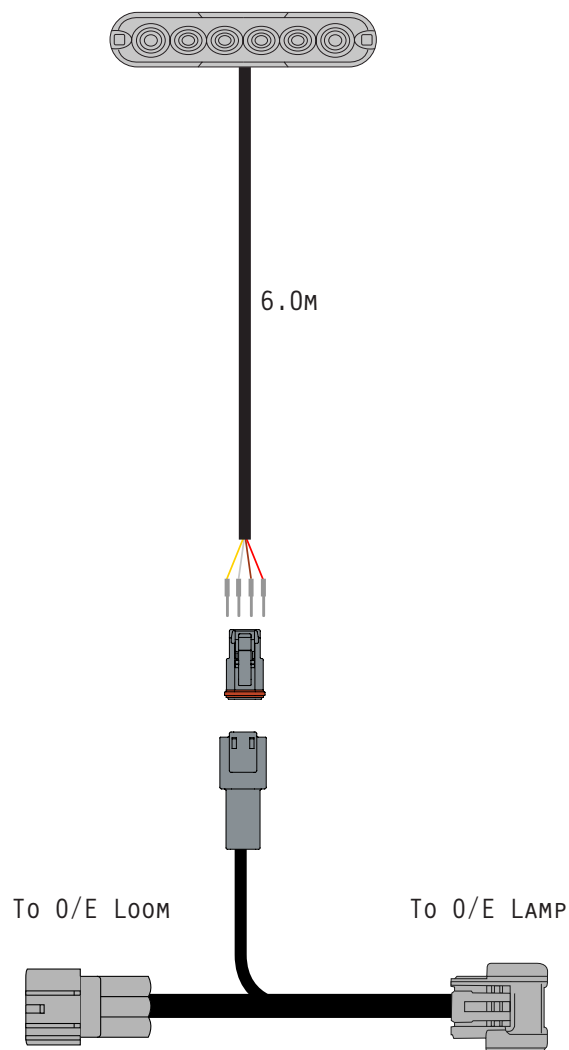

The Rigid Body trucks can also benefit from this system with many possibilities to advance your lighting and wiring options. We now offer a Break-Out Patch Cable that taps into the vehicles' existing rear lighting harness, enabling the addition of high-level combination lamps without time-consuming wiring. This innovative system will give you the flexibility and adaptability to compliment your O/E fitting requirements saving you time and money.

**We have break-out patch cables to suit many Rigid Truck Brands. Moving forward, we will be working on future models. If you require a specific application, please do not hesitate to discuss it with your LED Autolamps representative.**



# Rigid Body Kits - Break Out Patches for High Level Rear Lamps



**12 Series** - SIZE 131MM X 30MM X 8MM

Part No	Voltage	Function/Description
12ARM6-DT04	12/24V	STOP/TAIL/INDICATOR 6M CABLE WITH 2 X DEUTSCH CONNECTOR



**201 Series** - SIZE 200MM X 50MM X 28MM

Part No	Voltage	Function/Description
201BSTIMDT3M (3 METRE CABLE)	12/24V	STOP/TAIL/INDICATOR 3 OR 6M CABLE WITH 2 X DEUTSCH CONNECTOR
201BSTIMDT6M (6 METRE CABLE)		



**135 Series** - SIZE 135MM X 38MM X 24MM

Part No	Voltage	Function/Description
135ARMDT6M	12/24V	STOP/TAIL/INDICATOR 6M CABLE WITH 2 X DEUTSCH CONNECTOR



## Break-Out Patch Cable

Part No	Function/Description
SEE VEHICLE APPLICATION GUIDE	BREAKS OUT FROM THE O/E REAR PLUG.

## Rigid Body - Test

WHEN USED TOGETHER, THE TEST-BOX12V & TEST-237CSB ALLOWS YOU TO;

- 1) ISOLATE
- 2) DIAGNOSE
- 3) CHECK

EVERY SECTION AND COMPONENT OF THE RBK HARNESSING KITS.



**P/N: TEST-BOX12V**

FUNCTION SWITCH BOX WITH RECHARGEABLE BATTERY AND 3 METRES OF CABLE



**P/N: TEST-237CSB**

MULTI-FIT ADAPTER TO TEST THE HARNESS SIGNAL FOR THE 2, 3, & 7 CORE CABLE.

USING THE TEST-LIGHTMV MAKES IT AN EASY TASK TO ENSURE ALL LIGHTING OUTPUTS RECEIVED FROM THE VEHICLE WORK CORRECTLY. RECOMMENDED FOR USE WITH REAR PATCH AND POWER PATCH HARNESSES.









**P/N: TEST-LIGHTMV**

LIGHT INCLUDED TO TEST THE VEHICLE SIGNAL

# HINO



Patch Application	Part No.	Picture	Notes	Truck
 PLUGGED REAR PATCH CABLE	PATCH-HINO (INCLUDES X2 CABLES)		LIGHTING SEE PAGE 6-9	
 POWER HARNESS SYSTEM	BOPATCH-HINO. STI (INCLUDES X2 CABLES)			

# HINO 300



Patch Application	Part No.	Picture	Notes	300
 PLUGGED REAR PATCH CABLE	PATCH-HINO300 (INCLUDES X2 CABLES)			
 POWER HARNESS SYSTEM	PPATCH-HINO300 (INCLUDES X1 CABLE)			
 POWER HARNESS SYSTEM	BOPATCH-H300.STI (INCLUDES X2 CABLES)			
 POWER HARNESS SYSTEM	BOPATCH-HINO.T		POWERS SIDE MARKERS BY PATCHING INTO THE O/E LICENCE PLATE LAMP HARNESS	



# HINO 500



Patch Application	Part No.	Picture	Notes	FC	FD
 PLUGGED REAR PATCH CABLE	PATCH-HIN0500 (INCLUDES X2 CABLES)				
 POWER HARNESS SYSTEM	PPATCH-HIN0500 (INCLUDES X1 CABLE)		FC TIPPER & FL MODELS HAVE DIFFERENT PIN CONFIGURATIONS		
 POWER HARNESS SYSTEM	BOPATCH-H500.STI (INCLUDES X2 CABLES)				
 POWER HARNESS SYSTEM	BOPATCH-HIN0.T		POWERS SIDE MARKERS BY PATCHING INTO THE O/E LICENCE PLATE LAMP HARNESS		

# HINO 700



Patch Application	Part No.	Picture	Notes	700
 PLUGGED REAR PATCH CABLE	PATCH-HIN0700 (INCLUDES X2 CABLES)			
 POWER HARNESS SYSTEM	BOPATCH-HIN0.T		POWERS SIDE MARKERS BY PATCHING INTO THE O/E LICENCE PLATE LAMP HARNESS	
 POWER HARNESS SYSTEM	BBPATCH-HIN0700 (INCLUDES X1 CABLES)			

# ISUZU TRUCK



Patch Application	Part No.	Picture	Notes	N	F
 PLUGGED REAR PATCH CABLE	PATCH-ISUZU (INCLUDES X2 CABLES)		LIGHTING SEE PAGE 6-9		
 PLUGGED REAR PATCH CABLE	PATCH-ISUZUEXT (INCLUDES X2 CABLES)		USED TO EXTEND THE LOOM		
 POWER HARNESS SYSTEM	PPATCH-ISUZUN (INCLUDES X1 CABLE)		SUITS N SERIES		
 POWER HARNESS SYSTEM	PPATCH-ISUZUF (INCLUDES X1 CABLE)				
 POWER HARNESS SYSTEM	BOPATCH-ISUZU.STI (INCLUDES X2 CABLES)		SEE PAGES 38-39		
 DRIVING LAMPS LIGHT BAR	DLPATCH-ISUZUN (INCLUDES X1 CABLE)				
 DRIVING LAMPS LIGHT BAR	DLPATCH-ISUZUF (INCLUDES X1 CABLE)				

# IVECO DAILY/ EUROARGO



Patch Application	Part No.	Picture	Notes	Daily	Eurocargo
 PLUGGED REAR PATCH CABLE	PATCH-DAILY			●	
 PLUGGED REAR PATCH CABLE	PATCH-EU				●
 POWER HARNESS SYSTEM	PPATCH-EU (INCLUDES x1 KIT)				●
 POWER HARNESS SYSTEM	BOPATCH-EU.STI (INCLUDES x2 CABLES)				●
 POWER HARNESS SYSTEM	PPATCH-DAILYSM			●	





## NISSAN UD CRONER/QUON



Patch Application	Part No.	Picture	Notes	Croner	Quon
 POWER HARNESS SYSTEM	PPATCH-EU (INCLUDES x1 KIT)			●	●
 POWER HARNESS SYSTEM	BOPATCH-EU.STI (INCLUDES x2 CABLES)			●	●

## HYUNDAI MIGHTY EX



Patch Application	Part No.	Picture	Notes	EX
 PLUGGED REAR PATCH CABLE	PATCH-MIGHTYEX (INCLUDES x2 KIT)			●
 POWER HARNESS SYSTEM	BOPATCH-MIGHTYEX.STI (INCLUDES x2 CABLES)			●



# DAF LF/CF



Patch Application	Part No.	Picture	Notes	LF	CF
 POWER HARNESS SYSTEM	PPATCH-EU (INCLUDES X1 KIT)			●	
 POWER HARNESS SYSTEM	BOPATCH-EU.STI (INCLUDES X2 CABLES)			●	
 POWER HARNESS SYSTEM	PPATCH-DAF (INCLUDES X1 CABLE)				●
 POWER HARNESS SYSTEM	BOPATCH-DAF (INCLUDES X2 CABLES)				●

## VOLVO FE/FH/FM



Patch Application	Part No.	Picture	Notes	FE	FH	FM
 POWER HARNESS SYSTEM	PPATCH-VOLVO (INCLUDES x1 KIT)			<input checked="" type="checkbox"/>	<input checked="" type="checkbox"/>	<input checked="" type="checkbox"/>
 POWER HARNESS SYSTEM	BOPATCH-VOLVO.STI (INCLUDES x2 CABLES)			<input checked="" type="checkbox"/>	<input checked="" type="checkbox"/>	<input checked="" type="checkbox"/>

## SCANIA P & G9



Patch Application	Part No.	Picture	Notes	P Series	G9 Series
 POWER HARNESS SYSTEM	PPATCH-EU (INCLUDES x1 KIT)			<input checked="" type="checkbox"/>	<input checked="" type="checkbox"/>
 POWER HARNESS SYSTEM	BOPATCH-EU.STI (INCLUDES x2 CABLES)			<input checked="" type="checkbox"/>	<input checked="" type="checkbox"/>

# MITSUBISHI FUSO



Patch Application	Part No.	Picture	Notes	Fuso
 <p>PLUGGED REAR PATCH CABLE</p>	<p>PATCH-FUSO (INCLUDES X2 CABLES WITH LRM)</p>			
 <p>POWER HARNESS SYSTEM</p>	<p>BOPATCH-FUSO,STI (INCLUDES X1 CABLES)</p>			
 <p>POWER HARNESS SYSTEM</p>	<p>PPATCH-FUSO (INCLUDES X1 KIT)</p>			



## Rigid Body Kits - Accessories



### Reverse Beeper/Squawker

Part No	Function
2PF200RAB	REVERSE BEEPER 200MM CABLE 102DB FIXED
2PF200ETB	REVERSE BEEPER 200MM CABLE 102DB FIXED
2PF200SQB	REVERSE SQUAWKER 200MM CABLE 102DB FIXED



### 97 Series Multi-fit Bracket

Part No	Function
97BKTBS	MULTI-FIT BACK-SET BRACKET WITH AMBER REFLECTOR/RIVETS (ALSO SUITS 42 SERIES)
97BKT	MULTI-FIT BRACKET WITH AMBER REFLECTOR/RIVETS
97BKT90	90° ANGLE BRACKET WITH AMBER REFLECTOR/RIVETS



### Interior/Exterior Lamp

Part No	Function
13118WM-PIR	LARGE ROUND INTERIOR/ EXTERIOR LAMP WITH PIR SENSOR



### Interior/Exterior Lamp

Part No	Function
16606WM-PIR	LARGE OVAL INTERIOR/ EXTERIOR LAMP WITH PIR SENSOR



### Work/Reverse Lamp

Part No	Function
7312BMCSB	FLOOD LAMP WITH 2 CORE FEMALE PLUG



### Work/Reverse Lamp

Part No	Function
7512BMCSB	FLOOD LAMP WITH 2 CORE FEMALE PLUG



# Rigid Body Kits - Accessories



METAL TYPE  
ALSO AVAILABLE

## 7 Pin Large Round Trailer Sockets

Part No	Function
PPATCH-7PS	ROUND TRAILER SOCKET
PPATCH-7PSHD12	HEAVY DUTY METAL ROUND TRAILER SOCKET



METAL TYPE  
ALSO AVAILABLE

## 7 Pin Flat Trailer Sockets

Part No	Function
PPATCH-7PFS	FLAT TRAILER SOCKET
PPATCH-7PFSHD12	HEAVY DUTY METAL FLAT TRAILER SOCKET



## Licence Plate Resistor

Part No	Function
2PM.5LP	MALE T10 TO CSB PLUG (PAIR) 12V ONLY
2PM.5LPDT	2 PIN DEUTSCH PLUGS (PAIR) 12V ONLY



METAL TYPE  
ALSO AVAILABLE

## 7 Pin Small Round Trailer Socket

Part No	Function
PPATCH-7PSRS	SMALL ROUND TRAILER SOCKET
PPATCH-7PSRSHD	HEAVY DUTY METAL SMALL ROUND TRAILER SOCKET



## Voltage Reducer

Part No	Function
PPATCH-VRM	POWER PATCH WITH 10AMP VOLTAGE REDUCER 12V-24V
PPATCH-VRL	POWER PATCH WITH 20AMP VOLTAGE REDUCER 12V-24V



## Universal Power Patch Cable Left/Right

Part No	Function
PPATCH-UNI.STI	POWER PATCH, JOINS LEFT & RIGHT FOR SINGLE OUTPUT





## Rigid Body Kits - Accessories



### Universal Power Patch Cable

Part No	Function
PPATCH-UNI	POWER PATCH FOR UNI FIT (1x 6 PIN)



### Universal Power Patch Cable

Part No	Function
PPATCH-UNIDTS	POWER PATCH FOR UNI FIT (1x 6 PIN)



### Trailer Lighting Module

Part No	Function
PPATCH-CANBUS	PREVENT CANBUS ERRORS WHEN CONNECTING TRAILER/CARAVAN



### 3 Way Power Patch Splitter

Part No	Function
BOPATCH-6P3W	3 WAY POWER PATCH WITH DT CONNECTORS



### Marker Cable

Part No	Function
2PFDT04-2P	2 CORE, 250MM, CS FEMALE TO DT04-2P



INCLUDED IN APPLICABLE KITS

### RBK Adapter

Part No	Function
PPATCH-RBK7C	POWER PATCH TO RBK ADAPTER FOR 7 CORE



## Rigid Body Kits - Accessories



### RBK Adapter

Part No	Function
3PF2PMI.2B	200MM 3 CORE TO 2 CORE INDICATOR ADAPTER CABLE



### RBK Adapter

Part No	Function
3PF2PMT.2B	200MM 3 CORE TO 2 CORE TAIL ADAPTER CABLE



### RBK Adapter

Part No	Function
PPATCH-RBK3C	POWER PATCH TO RBK ADAPTER FOR 2&3 CORE



### RBK Adapter

Part No	Function
3PFTIB	200MM 3 CORE WITH 2 CORE MARKER AND 2 CORE INDICATOR EXTENSIONS



### Harness Toggle Switch

Part No	Function
TSWITCH.25B	TOGGLE SWITCH 0.25M CABLE EACH SIDE
TSWITCH.5B	TOGGLE SWITCH 0.5M CABLE EACH SIDE
TSWITCH3B	TOGGLE SWITCH 3M CABLE EACH SIDE



### Harness Push/Pull Switch

Part No	Function
PPSWITCH.25B	PUSH/PULL SWITCH 0.25M CABLE EACH SIDE
PPSWITCH.5B	PUSH/PULL SWITCH 0.5M CABLE EACH SIDE
PPSWITCH3B	PUSH/PULL SWITCH 3M CABLE EACH SIDE



# Rigid Body Kits - Accessories System Adaptability

## Power Harness Direct to loom

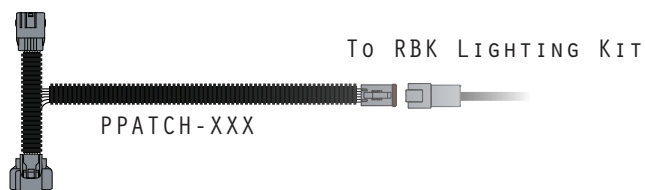

## Power Harness using 3 Way Splitter

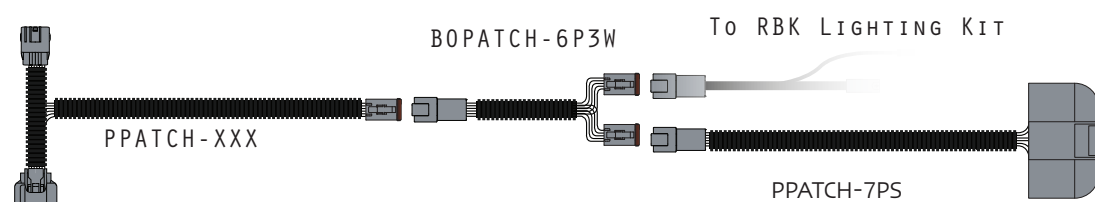

## Power Harness Direct to Trailer Plug

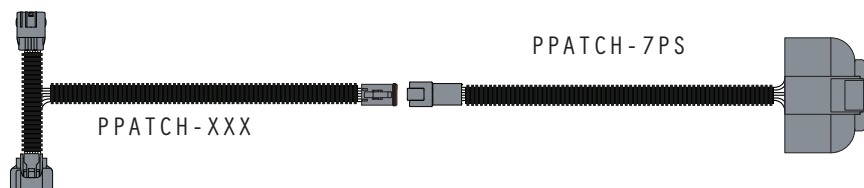

## Power Harness using 3 Way Splitter

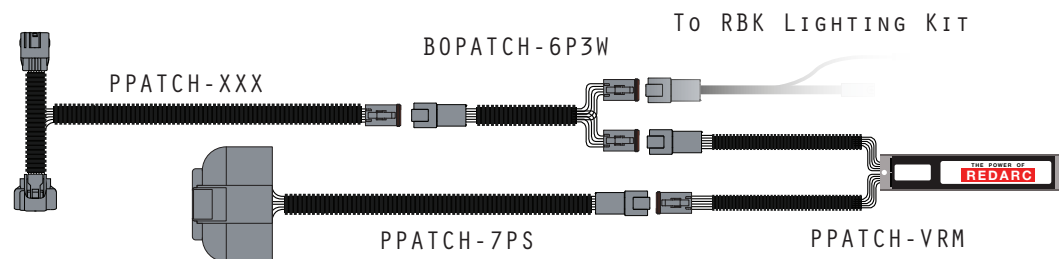

**Ask your LED Autolamps representative for a solution that suits you.**



# Rigid Body Kits - Interior Lighting

## Van Interior Kit with Pull Switch

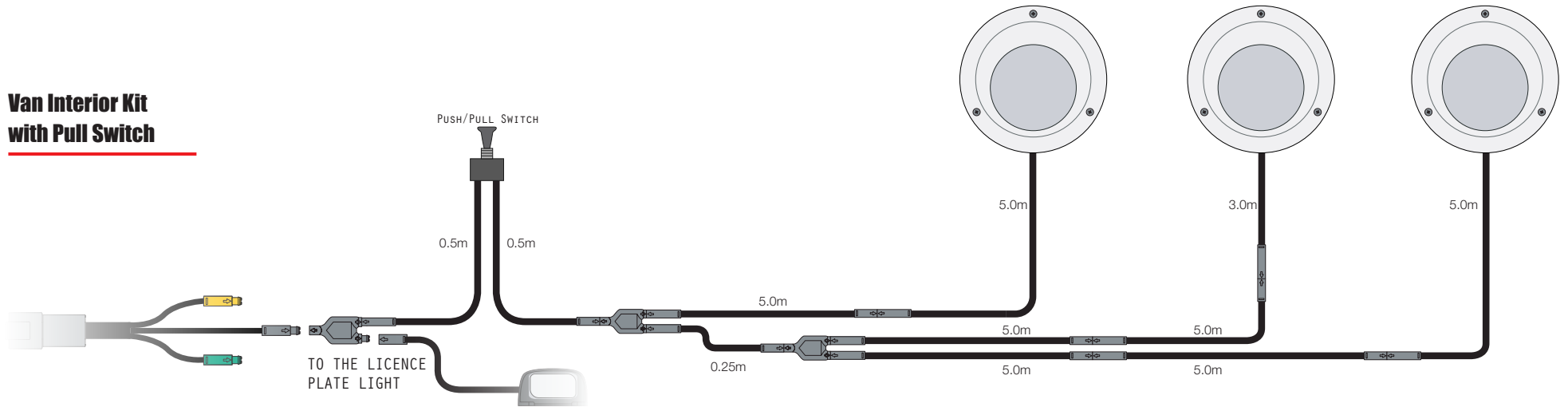

## Tailgate Interior Kit with Pull Switch

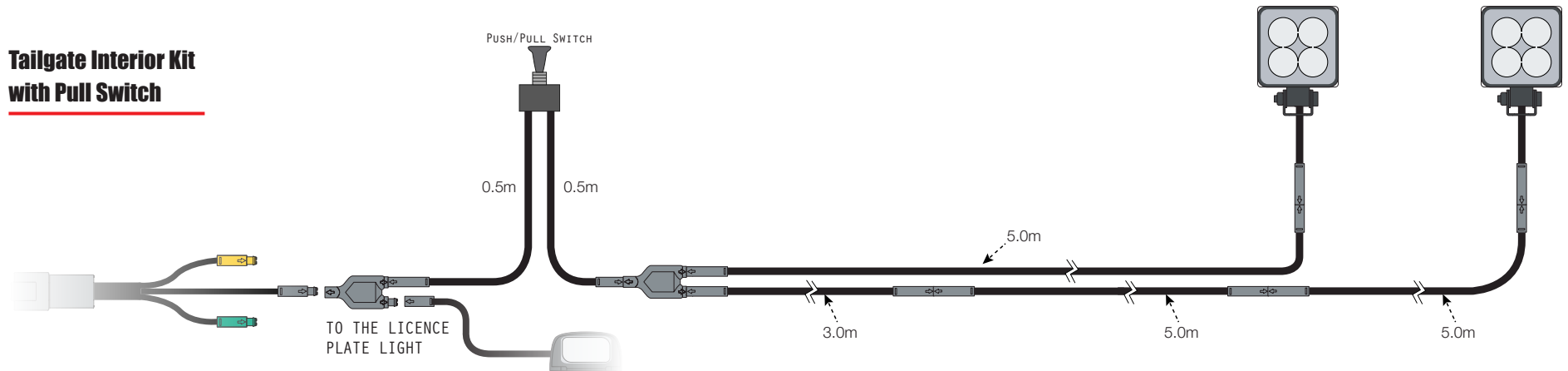

**Ask your LED Autolamps representative for a solution that suits you.**

# Vehicle Plugs and Connectors

Part No	OEM P/N	Side	Positions	Picture
PLUG-2P7029-1	6188-0552 6918-1774	MALE	2	
PLUG-CAT6TOY-OTA	90980-11168	MALE	2	
PLUG-2P7021-1	6187-2311	MALE	2	
PLUG-2P7023-1	NULL	MALE	2	
PLUG-2P7025-1	6180-2405 90980-11155	MALE	2	
PLUG-DT04-2P	DT04-2P	MALE	2	

Part No	OEM P/N	Side	Positions	Picture
PLUG-2P7029	6185-0865	FEMALE	2	
PLUG-2P7021G	7283-7526-40 90980-11162	FEMALE	2	
PLUG-2P7021	6180-2321	FEMALE	2	
PLUG-2P7023	6189-0175 90980-11019	FEMALE	2	
PLUG-2P7025	7283-8125 6189-0249 PB195-02047 90980-11156	FEMALE	2	
PLUG-DT06-2S	DT06-2S	FEMALE	2	







# Vehicle Plugs and Connectors

Part No	OEM P/N	Side	Positions	Picture
PLUG-282105-1	282105-1	MALE	3	
PLUG-DT04-3P	DT04-3P	MALE	3	
PLUG-DT04-4P	DT04-4P	MALE	4	
PLUG-FUS0	NULL	MALE	6	
PLUG-ISUZU-1	FW-C-6M-B	MALE	6	
PLUG-HILUX. LCRUISER	90980-10987	MALE	6	

Part No	OEM P/N	Side	Positions	Picture
PLUG-282087-1	282087-1	FEMALE	3	
PLUG-DT06-3S	DT06-3S	FEMALE	3	
PLUG-DT06-4S	DT06-4S	FEMALE	4	
PLUG-FUS0-1	NULL	FEMALE	6	
PLUG-ISUZU	FW-C-6F-B	FEMALE	6	
PLUG-6P7061L		FEMALE	6	

# Vehicle Plugs and Connectors

Part No	OEM P/N	Side	Positions	Picture
PLUG-HINO	6187-6561	MALE	6	
PLUG-HINO300	6188-0175 90980-11193	MALE	6	
PLUG-DT04-6P	DT04-6P	MALE	6	
PLUG-NP300	6188-0560	MALE	6	
PLUG-6P7061-1	33482-3601 33482-0601	MALE	6	
PLUG-6P7061R	7282-7062-40 MG651104-5	MALE	6	

Part No	OEM P/N	Side	Positions	Picture
PLUG-HINO-1	6180-6771	FEMALE	6	
PLUG-TRITONMQ	6189-0323 90980-11663 90980-11194	FEMALE	6	
PLUG-DT06-6S	DT06-6S	FEMALE	6	
PLUG-6P7069B	6185-1175 PB295-06120	FEMALE	6	
PLUG-6P7061	33472-0606	FEMALE	6	
PLUG-6P7061R-1	MG641107-5 90980-11034	FEMALE	6	

# Vehicle Plugs and Connectors

Part No	OEM P/N	Side	Positions	Picture
PLUG-6P7067	7182-9331-30	MALE	6	
PLUG-DMAX	7222-7464-30	MALE	6	
PLUG-8P7089B-1.5-21B	1-1564512-1	MALE	6	
PLUG-7P3072-1.5-11B	1718230-1	MALE	7	
PLUG-8P7082B	7222-7484-30	MALE	8	
PLUG-8P7089B	6188-0738 6918-1780	MALE	8	

Part No	OEM P/N	Side	Positions	Picture
PLUG-BT50	7283-9332-30	FEMALE	6	
PLUG-6P7061B	7123-7464-30	FEMALE	6	
PLUG-8P7089B-1.5-11B	1-1670894-1	FEMALE	6	
PLUG-7P3072-1.5-21B	967650-1 1-1813344-1	FEMALE	7	
PLUG-LDV	7123-7484-30	FEMALE	8	
PLUG-8P7089B-1	6185-1179 6918-1780	FEMALE	8	



## **LED Autolamps**

439 Boundary Road  
Truganina, Victoria 3029  
Phone 1800 815 000

Email [esgapcustomerservice@esg.global](mailto:esgapcustomerservice@esg.global)  
Website [www.ledautolamps.com](http://www.ledautolamps.com)

### **DISCLAIMER**

LED Autolamps has made every effort to ensure that the measurements and information contained in this catalogue are correct and accurate. Before orders are placed, especially before any commencement of manufacturing, please check all measurements and information. LED Autolamps reserves the right to improve, modify the dimensional design and or make technical changes or discontinue or update designs without prior notice. However, we will take all measures to inform our customers if and when possible of any changes made. LED Autolamps will not accept liability of any kind due to misuse or abuse of any products not used as intended.

**Printed July 2024  
Version 5.8**